

Report

Report no. 14/20

Review of water treatment systems for PFAS removal



Review of water treatment systems for PFAS removal

This report was prepared by:

M. Riegel (DVGW-Technologiezentrum Wasser (TZW))
S. Egner (DVGW-Technologiezentrum Wasser (TZW))
F. Sacher (DVGW-Technologiezentrum Wasser (TZW))

Under the supervision of:

B. Scholtissek (Concawe Science Executive)
M. Hjort (Concawe Science Associate)
B. Beuthe, (Concawe Special Task Force on Soil and Groundwater (WQ/STF-33))
M. Bonte, (Concawe Special Task Force on Soil and Groundwater (WQ/STF-33))

At the request of:

Concawe Special Task Force on Soil and Groundwater (WQ/STF-33)

Thanks for their contribution to:

- Members of WQ/STF-33 (S. Demeure, M. Dunk. and C. Pisano)
- G. Whale (Whale Environmental Consultancy Ltd) for editing and improving the language of the report

Reproduction permitted with due acknowledgement

ABSTRACT

The group of perfluoroalkyl and polyfluoroalkyl substances (PFAS) is a large family of anthropogenic substances with a wide range of industrial applications. Due to their specific properties, PFAS are also used as ingredients in many formulations of Class B firefighting foams designed to fight flammable liquid fires. PFAS can and have been released into the environment during firefighting events, testing of firefighting equipment or firefighting training exercises. Due to the persistence, bioaccumulation potential and toxicity of several members of the PFAS family these substances are regarded as environmental contaminants of concern. Several regulations have been recently introduced, which restricts the manufacture and use of PFAS substances, particularly those containing more than six fully fluorinated carbon atoms.

Due to their numerous and widespread uses, mobility and persistence, PFAS are ubiquitous environmental contaminants. They have also been found at oil refinery sites in soils and groundwaters as a consequence of their historic use. As such there is an interest in removing PFAS from fire fighting (also referred to as fire-extinguishing) water run-off and groundwater in contaminated areas. This is the second of two Concawe reports on PFAS. The first report (Concawe report no. 8/16) provided an overview of the environmental fate and effects of poly- and perfluoroalkyl substances. This second report critically evaluates technologies and treatment systems for removing PFAS from both fire fighting water and groundwater. Firefighting water is likely to have PFAS concentrations which are two orders of magnitude higher than in groundwater, along with several co-contaminants. While groundwater may require pre-treatment, for example to remove ferrous iron which can cause clogging issues.

The technologies under consideration can be grouped in four main categories:

1. Adsorption technologies, including activated carbon, resins and novel PFAS-specific absorbents;
2. Flocculation technologies,;
3. Liquid-liquid separation technologies, including nanofiltration and reverse-osmosis, foam fractionation, and distillation; and,
4. Destructive technologies, including electrochemical degradation, sonochemistry, UV radiation, plasma destruction and water incineration.

A brief description of each technology is provided, followed by an evaluation of their suitability to remove different PFAS from either firefighting water or groundwater. The evaluation of both types of water was undertaken because some technologies may only be suitable for specific PFAS concentration ranges which may preclude their use depending on the type of water to be addressed. When available each evaluation is supported with technology case studies which are summarised in the Appendix to this report.

The results of the evaluation towards different criteria are summarized in lookup tables for groundwater treatment and fire-extinguishing water treatment, respectively, allowing an informed selection of the most suitable technology for a given scenario.

KEYWORDS

PFAS (per- and polyfluoroalkyl substances), PFCA (per- and polyfluoroalkyl carboxylic acids), PFSA (per- and polyfluoroalkyl sulfonic acids), long-chain, short-chain, precursors, treatment technologies, groundwater, firefighting water, comparative evaluation

INTERNET

This report is available as an Adobe pdf file on the Concawe website (www.concawe.eu).

NOTE

Considerable efforts have been made to assure the accuracy and reliability of the information contained in this publication. However, neither Concawe nor any company participating in Concawe can accept liability for any loss, damage or injury whatsoever resulting from the use of this information.

This report does not necessarily represent the views of any company participating in Concawe.

CONTENTS		Page
SUMMARY		VIII
1.	INTRODUCTION	1
2.	LITERATURE REVIEW	2
3.	PER- AND POLYFLUOROALKYL SUBSTANCES (PFAS)	4
3.1.	OVERVIEW	4
3.2.	TOXICOLOGICAL THRESHOLD VALUES	6
3.3.	INGREDIENTS OF FIREFIGHTING FOAMS	7
3.4.	COMPOSITION OF PFAS CONTAMINATED GROUNDWATERS	9
3.5.	COMPOSITION OF FIREFIGHTING WATERS	10
4.	APPROACH OF TECHNOLOGY EVALUATION	11
4.1.	TREATMENT SCENARIOS	11
4.2.	PFAS OF INTEREST	11
4.3.	INITIAL PFAS CONCENTRATIONS AND WATER MATRIX	11
4.4.	TREATMENT GOALS	12
4.5.	EVALUATION CRITERIA	13
5.	PFAS REMOVAL TECHNOLOGIES	14
5.1.	SORPTION TECHNOLOGIES	14
5.1.1.	Activated carbon	16
5.1.1.1.	General description and PFAS removal mechanism	16
5.1.1.2.	PFAS removal efficiency and costs	16
5.1.1.3.	Sensitivity to water matrix components	17
5.1.1.4.	Pre-treatment requirements and residue management	17
5.1.1.5.	Case studies	18
5.1.1.6.	Knowledge gaps	18
5.1.2.	MatCare	18
5.1.2.1.	General description and PFAS removal mechanism	18
5.1.2.2.	PFAS removal efficiency and costs	19
5.1.2.3.	Sensitivity to water matrix components	19
5.1.2.4.	Pre-treatment requirements and residue management	19
5.1.2.5.	Case studies	20
5.1.2.6.	Knowledge gaps	20
5.1.3.	RemBind	20
5.1.3.1.	General description and PFAS removal mechanism	20
5.1.3.2.	PFAS removal efficiency and costs	21
5.1.3.3.	Sensitivity to water matrix components	21
5.1.3.4.	Pre-treatment requirements and residue management	22
5.1.3.5.	Case studies	22
5.1.3.6.	Knowledge gaps	22
5.1.4.	Ion exchange (single use or with regeneration)	22
5.1.4.1.	General description and PFAS removal mechanism	22
5.1.4.2.	PFAS removal efficiency and costs	23
5.1.4.3.	Sensitivity to water matrix components	24
5.1.4.4.	Pre-treatment requirements and residue management	24
5.1.4.5.	Case studies	24
5.1.4.6.	Knowledge gaps	24
5.1.5.	CustoMem (single use or with regeneration)	25
5.1.5.1.	General description and PFAS removal mechanism	25
5.1.5.2.	PFAS removal efficiency and costs	25
5.1.5.3.	Sensitivity to water matrix components	26

5.1.5.4.	Pre-treatment requirements and residue management	26
5.1.5.5.	Case studies	26
5.1.5.6.	Knowledge gaps	26
5.1.6.	Cyclodextrin-based adsorbent (single use or with regeneration)	26
5.1.6.1.	General description and PFAS removal mechanism	26
5.1.6.2.	PFAS removal efficiency and costs	27
5.1.6.3.	Sensitivity to water matrix components	28
5.1.6.4.	Pre-treatment requirements and residue management	28
5.1.6.5.	Case studies	29
5.1.6.6.	Knowledge gaps	29
5.2.	PRECIPITATION / FLOCCULATION	29
5.2.1.	PerfluorAd	30
5.2.1.1.	General description and PFAS removal mechanism	30
5.2.1.2.	PFAS removal efficiency and costs	30
5.2.1.3.	Sensitivity to water matrix components	31
5.2.1.4.	Pre-treatment requirements and residue management	31
5.2.1.5.	Case studies	31
5.2.1.6.	Conclusions and knowledge gaps	32
5.2.2.	InSite	32
5.2.2.1.	General description and PFAS removal mechanism	32
5.2.2.2.	PFAS removal efficiency and costs	33
5.2.2.3.	Sensitivity to water matrix components	34
5.2.2.4.	Pre-treatment requirements and residue management	34
5.2.2.5.	Case studies	34
5.2.2.6.	Knowledge gaps	34
5.3.	LIQUID-LIQUID SEPARATION TECHNOLOGIES	34
5.3.1.	Nanofiltration/Reverse Osmosis	35
5.3.1.1.	General description and PFAS removal mechanism	35
5.3.1.2.	PFAS removal efficiency and costs	35
5.3.1.3.	Sensitivity to water matrix components	36
5.3.1.4.	Pre-treatment requirements and residue management	36
5.3.1.5.	Case studies	36
5.3.1.6.	Knowledge gaps	36
5.3.2.	Foam fractionation and ozofractionation	36
5.3.2.1.	General description and PFAS removal mechanism	36
5.3.2.2.	PFAS removal efficiency and costs	38
5.3.2.3.	Sensitivity to water matrix components	38
5.3.2.4.	Pre-treatment requirements and residue management	39
5.3.2.5.	Case studies	39
5.3.2.6.	Knowledge gaps	39
5.3.3.	Adsorptive liquid-liquid separation	39
5.3.4.	Vacuum distillation	40
5.4.	DESTRUCTION TECHNOLOGIES	40
5.4.1.	Electrochemical degradation	40
5.4.1.1.	General description and PFAS removal mechanism	40
5.4.1.2.	PFAS removal efficiency and costs	41
5.4.1.3.	Sensitivity to water matrix components	41
5.4.1.4.	Pre-treatment requirements and residue management	42
5.4.1.5.	Case studies	42
5.4.1.6.	Knowledge gaps	42
5.4.2.	Oxidation processes	42
5.4.2.1.	General description and PFAS removal mechanism	42
5.4.2.2.	PFAS removal efficiency and costs	43
5.4.2.3.	Sensitivity to water matrix components	43
5.4.2.4.	Pre-treatment requirements and residue management	44

5.4.2.5.	Case studies	44
5.4.2.6.	Knowledge gaps	44
5.4.3.	Sono-chemistry	44
5.4.3.1.	General description and PFAS removal mechanism	44
5.4.3.2.	PFAS removal efficiency and costs	45
5.4.3.3.	Sensitivity to water matrix components	45
5.4.3.4.	Pre-treatment requirements and residue management	45
5.4.3.5.	Case studies	45
5.4.3.6.	Knowledge gaps	45
5.4.4.	UV radiation	46
5.4.4.1.	General description and PFAS removal mechanism	46
5.4.4.2.	PFAS removal efficiency and costs	46
5.4.4.3.	Sensitivity to water matrix components	46
5.4.4.4.	Pre-treatment requirements and residue management	47
5.4.4.5.	Case studies	47
5.4.4.6.	Knowledge gaps	47
5.4.5.	Vacuum distillation with plasma destruction	48
5.4.5.1.	General description and PFAS removal mechanism	48
5.4.5.2.	PFAS removal efficiency and costs	49
5.4.5.3.	Sensitivity to water matrix components	49
5.4.5.4.	Pre-treatment requirements and residue management	50
5.4.5.5.	Case studies	50
5.4.5.6.	Knowledge gaps	50
5.4.6.	Nanoscale zerovalent iron	50
5.4.6.1.	General description and PFAS removal mechanism	50
5.4.6.2.	PFAS removal efficiency and costs	51
5.4.6.3.	Sensitivity to water matrix components	51
5.4.6.4.	Pre-treatment requirements and residue management	52
5.4.6.5.	Case studies	52
5.4.6.6.	Knowledge gaps	52
5.4.7.	Water incineration	52
5.4.7.1.	General description and PFAS removal mechanism	52
5.4.7.2.	PFAS removal efficiency and costs	53
5.4.7.3.	Sensitivity to water matrix components	53
5.4.7.4.	Pre-treatment requirements and residue management	53
5.4.7.5.	Case studies	53
5.4.7.6.	Knowledge gaps	53
6.	COMPARISON OVERVIEW	54
6.1.	GROUNDWATER TREATMENT	54
6.2.	FIREFIGHTING WATER TREATMENT	60
7.	CASE STUDIES OVERVIEW	64
7.1.	ACTIVATED CARBON	64
7.2.	MATCARE	66
7.3.	REMBIND	68
7.4.	ION EXCHANGE	69
7.5.	CUSTOMEM	70
7.6.	CYCLODEXTRIN-BASED ADSORBENTS	71
7.7.	PERFLUORAD	74
7.8.	INSITE	74
7.9.	NANOFILTRATION / REVERSE OSMOSIS	76
7.10.	FOAM FRACTIONATION AND OZOFRACTIONATION	76
7.11.	ELECTROCHEMICAL DEGRADATION	78
7.12.	OXIDATION PROCESSES	79
7.13.	SONO-CHEMISTRY	80

	7.14.	UV RADIATION	81
	7.15.	VACUUM DISTILLATION WITH PLASMA DESTRUCTION	81
	7.16.	NANOSCALE ZEROVALENT IRON	82
	7.17.	WATER INCINERATION	83
8.		ABBREVIATIONS	84
9.		REFERENCES	86

SUMMARY

Background

As a consequence of the widespread use of perfluoroalkyl and polyfluoroalkyl substances (PFAS) in industrial and household products combined with their mobility and persistence properties, these substances are widely distributed in the global environment. Fluorinated foams have been used since the 1960s for the suppression of class B (flammable liquid) fires at airports, refineries and other major petroleum facilities (Concawe, 2016). Their use in Class B firefighting foams during fire incidents or firefighting training exercises at oil refineries and oil storage facilities can result in contamination of soils and the aquatic environment. This is the second of two Concawe reports on PFAS. The first report (Concawe report no. 8/16) provided an overview of the environmental fate and effects of poly- and perfluoroalkyl substances. Controls have recently been put in place to avoid using long-chained PFAS in foam due to their toxicological profile. Their use has been challenged due to concern that certain poly and perfluoroalkyl substances (PFAS) used in these foams have PBT characteristics (Persistent, Bioaccumulative and Toxic). However, due to concerns related to contamination associated with the historic use of these foams and continued/future use of shorter chained PFAS as possible replacements there is interest in removing these substances from water [3, 4, 5, 8].

The unique physical and chemical properties of PFAS combined with the variety of their chemical structures makes treatment to remove PFAS from water challenging. Conventional drinking water treatment processes, such as coagulation/flocculation, air stripping or rapid sand filtration are ineffective in removal of PFAS from water. Consequently, a new market has evolved with novel technologies that explicitly address PFAS removal [3, 4, 8].

Currently, performance data regarding the removal efficiency for PFAS of these novel technologies is limited. In most cases, only information about the elimination of perfluorooctane sulfonic acid (PFOS) and perfluorooctanoic acid (PFOA) is available; these are two of the most abundant, and widely studied and regulated PFAS, which are also ubiquitous and widely detected in various biological and environmental matrices. In the past decade, however, the active ingredients in Class B foams have changed and short-chain PFAS and precursor substances are of increasing importance [3, 4, 8]. Hence, a more profound evaluation of the relevant technologies is mandatory to design future PFAS treatment systems with great remediation success and high economic efficiency.

Objective and technology evaluation

To meet the challenge outlined above, a literature review was undertaken summarizing available performance data of both well-established and novel treatment technologies. Focus was set on *ex-situ* treatment technologies with treatment efficiency considered separately for groundwater and water collected from firefighting events (firefighting water). PFAS concentrations in contaminated groundwater are typically in the µg/L range although large volumes of water must be treated. In firefighting water, much higher PFAS concentrations up to the mg/L range are present, but the water volume is typically limited to some hundreds or thousands of cubic metres.

Evaluation of each technology was undertaken by:

- assessing its efficiency for removing different PFAS components;
- technology-specific constraints (e.g. sensitivity to water matrix components);
- pre-treatment requirements to enable technology to operate according to the technical standards;
- energy demand;
- chemical requirements for the waste management and
- operational costs.

Technologies considered for PFAS treatment

A total of seventeen technologies were considered in this review. These technologies were divided into four groups:

1. *Sorption technologies;*
2. *Flocculation technologies;*
3. *Liquid-liquid-separation technologies and*
4. *Destruction technologies.*

For each group key parameters were defined that yield the most important evaluation criteria to enable a comparison of the technologies within the group.

In general, sorption, flocculation and liquid-liquid separation concentrates PFAS in a solid or a liquid phase requiring further processing of the PFAS-enriched residue, e.g. loaded adsorbent material, sludge or concentrate [1, 3, 4, 44]. Destruction-based technologies achieve PFAS degradation and consequently might provide a more sustainable solution as these do not produce residual amounts of PFAS [2, 4, 88, 90, 92].

Sorption technologies include different sorbent materials such as *activated carbon*, *MatCare*, *RemBind*, *Ion Exchange resins*, *CustoMem* and *cyclodextrin-based adsorbents*. The most common application uses a flow-through fixed-bed filter vessel and the technical complexity of these systems is relatively low in comparison to other treatment options [4, 5]. The main cost drivers are material consumption and the disposal costs for spent material (reactivation or incineration) [1, 3, 4, 55, 67, 124, 127]. Pre-treatment is required for water matrices containing iron or manganese [46, 64].

In principle, efficient removal of PFAS from water is feasible until the target substances break through the filter bed. Therefore, the key parameter, especially when used for groundwater treatment, is the operation time or the respective loading capacity of the adsorbent until the spent material must be replaced [54, 117, 118]. Both, activated carbon and ion exchange resins are field-proven technologies with reliable performance data available from pilot and full-scale treatment of real water matrices. For these technologies, long operation times are required, especially for long-chain PFAS [3, 47, 56, 71, 117, 118, 119]. Vendors of novel adsorbents claim better performance for water with potentially competing components and higher performance for short-chain PFAS removal [52, 53, VENDOR]. However, reliable data on achievable operation times treating groundwater with relevant water matrix components are currently unavailable.

Flocculation technologies including *PerfluorAd* and *InSite* require frequent flocculent dosage, stirring tanks and separation of the PFAS-loaded flocs (via filtration or sedimentation). The technical implementation is more complex than adsorption filtration. Normally, a polishing step is required to reach lower PFAS concentrations [4, VENDOR 73, 74, VENDOR 76]. The operational costs are mainly governed by the costs for the chemical additives and the sludge disposal [4]. Pre-treatment is necessary for manganese containing waters and if the polishing step is susceptible to co-contaminants, which do not co-precipitate during the flocculation stage [4].

Key parameters are the flocculent dosage and the respective PFAS elimination with the removal efficiency strongly dependent on the flocculent dosage [4]. *PerfluorAd* has been applied in pilot and full-scale applications and, using moderate dosages, high removal efficiencies were obtained [4, VENDOR 75]. *InSite* has been demonstrated at pilot-scale and high PFAS elimination is indicated, at least for a high flocculent dosage [VENDOR 76]. However, this should be taken with caution as the performance data regarding this *InSite* trial was only available from the vendor.

Liquid-liquid separation technologies concentrate the PFAS into a smaller amount of water. *Nanofiltration, reverse osmosis, foam fractionation (using air or ozone)* and *vacuum distillation* are considered within this report. Furthermore, *adsorptive technologies with regeneration* are considered as these are classified as a liquid-liquid separation. Nanofiltration, reverse osmosis, foam fractionation and distillation are technically more complex than adsorption filtration with regeneration [1, 4, 85]. It is expected that the main cost driver for the membrane filtration processes, foam fractionation and vacuum distillation is their energy demand. Pre-treatment requirements mainly involve removal of iron and manganese, however for technologies such as reverse osmosis additional steps to remove turbidity are a mandatory requirement [3, 83].

Key parameters driving costs are the energy demand and the residual amount of PFAS-enriched water which must undergo further treatment [4, 6, 83, 87]. Reverse osmosis is technically sophisticated and reliably removes all PFAS from water [2, 78, 79, 80, 81, 82]. However, the process leaves a relatively high volume of concentrate which, as is also the case with vacuum distillation, requires subsequent treatment [1, 87]. Pilot-scale data from foam fractionation indicates efficient removal of PFAS and small volumes of PFAS-enriched concentrate but the performance data were mainly provided by the vendor and not independently verified [4, VENDOR 84, VENDOR, 128]. The adsorptive technologies applied with regeneration normally provide a high separation factor and little energy input is needed. However, the current status and application of these technologies requires further development.

Destruction technologies include *electrochemical degradation, oxidation processes, sono-chemistry, UV radiation, plasma treatment* and *nanoscale zerovalent-iron* as well as *water incineration*. The destruction-based treatment should achieve a full degradation of the PFAS to fluorine and CO₂ [2, 4]. For these technologies the energy demand required to achieve full mineralization is the crucial key parameter [2, 4, 8, 80, 88, 102, 105, 107, 135]. The technical complexity of electrochemical degradation, oxidation, sonochemistry and UV radiation is relatively modest [4, 80, 96]. In contrast, plasma treatment, nanoscale zerovalent iron and water incineration including flue gas cleaning are more complex [23, 102, 107, 112].

High temperature incineration of hazardous liquids is a readily available commercial technology which is capable of completely removing PFAS [23]. With the exception of sono-chemistry and plasma treatment, which are available in pilot-scale, the performance data of the other technologies currently relies on lab-scale experience

[2, 89, 104, 108, 129, 132, 134, 135]. Most of the technologies have demonstrated potential to degrade PFAS completely but data is lacking of energy demand and costs in pilot scale and real world applications. Furthermore, co-contaminants may further increase energy demand and potentially cause the formation of toxic by-products [80, 90, 91, 92, 93, 98, 100].

Selection of the most appropriate technology

The technical maturity and availability of reliable data varied widely for the treatment technologies assessed in this review. More credibility is given to performance data derived from full-scale or pilot-scale application with field derived water matrices than results from lab-scale experiments conducted with PFAS in demineralized water. Performance data obtained through third party research and development (R&D) and reported in peer-reviewed literature is considered more credible than information provided by the vendors where the latter has not been subject to independent validation.

The remediation success of the different technologies strongly depends on site-specific conditions. Influent concentrations of PFAS, water volume and quality as well as the PFAS target concentrations strongly influence which technology or combination of several technologies should be selected. Ultimately, to achieve economic and high remediation efficiency a treatment train of several technologies in series might be the treatment process of choice [3, 4, 6].

Sorption technologies are expected to be capable of remove PFAS selectively from water and are suited to treating large volumes of water [4]. The selection of the most suitable adsorbent should be verified experimentally for a contaminated site. Very high influent concentrations could be managed by operation of several filters in series [3, 8]. Since a flocculation technology is capable to remove the bulk of PFAS, it might represent the first stage in a treatment train. Subsequent treatment will purify the water down to very low PFAS concentration levels [4]. The liquid-liquid separation technologies concentrate the PFAS and allow an economic benefit for further treatment, e.g. destruction-based technologies. Here, the adsorptive approaches that include a regeneration of the sorbent might be less expensive [8]. Destruction technologies typically represent the last step in a treatment train as these are best suited to treating small volumes of water containing high concentrations of PFAS. This is due to the high energy required to mineralize the PFAS effectively [2, 4, 8].

1. INTRODUCTION

Perfluoroalkyl and polyfluoroalkyl substances (PFAS) are ingredients (1 to 5%) in many formulations of Class B firefighting foams for flammable liquids [32, 34]. Some PFAS are qualified as PBT substances, i.e. they are Persistent, Bioaccumulative, and Toxic. Serious environmental concerns related to PFAS were raised in the past two decades, after five previous decades of widespread usage. Concern around the environmental effects of PFAS use began when it was realised that, due to their resistance to biodegradation, perfluorooctane sulfonic acid (PFOS) and perfluorooctanoic acid (PFOA) were ubiquitous and widely detected in various biological and environmental matrices. Simultaneously, it became clear that they could have effects on human health and the (aquatic) environment and could biomagnify [3, 4]. The degree of biomagnification is proportional to perfluorocarbon chain length and so regulation to restrict the manufacture and use of PFAS substances has focussed on PFAS containing more than 6 fully fluorinated carbon atoms [4, 9, 15, 16, 17]. Class B firefighting foams containing PFAS have been used at sites with bulk storage of hydrocarbons, including oil storage and refining facilities and both domestic and military airports. These foams have been historically used in emergencies to control fires and more routinely in fire-fighting exercises. Consequently, soil and groundwater may have been impacted by PFAS at sites where these foams have been used [23, 34, 62].

Currently, the remediation of PFAS contaminated sites is subject to research including field application studies and a growing market of technologies aiming at the removal of PFAS from environmental matrices is developing [3, 4, 5, 6]. Focusing on the treatment of contaminated groundwater and wastewater from firefighting events, seventeen established as well as emerging technologies have been compiled and critically evaluated in this report. These included different sorbents, chemical additives and approaches that aim at concentrating or at destruction of the PFAS. An evaluation was carried out using data from peer-reviewed literature and information provided by the vendor of the technologies. Furthermore, information on current knowledge state of developing and less mature technologies is provided.

This guidance document provides a general understanding of water treatment technologies that are applicable to remove PFAS from different water matrices. The reader can use this document to aid in the selection of the most appropriate and efficient treatment technology based on a knowledge of site conditions and the target effluent concentrations for the relevant PFAS. It must be emphasized, that this document intends to allow for an informed selection of appropriate technologies based on scientific and objective data. The report should not be considered as a recommendation for any of the presented technologies.

2. LITERATURE REVIEW

This literature review has used two previous literature investigations regarding PFAS elimination from groundwater and drinking water, which have been carried out by the author's research organisation TZW (DVGW-Technologiezentrum Wasser) between 2013 and 2017 [1, 2] and six other ones, which were published between 2014 and 2018 [3 - 8], to identify the technologies to be further investigated and evaluated.

Many conventional drinking water treatment technologies are ineffective in PFAS removal. For example, stripping, conventional flocculation, mechanical retention with ultrafiltration or sand filtration is not feasible to remove PFAS from water [3, 4].

PFAS can be removed by adsorption processes. Common and commercial PFAS adsorption technologies as well as innovative technologies with a lower technology readiness level are described in the literature [e.g. 3, 4, 5]. In addition to adsorption technologies, flocculation technologies using a special PFAS removing flocculent and destruction technologies are referenced [e.g. 2, 8, VENDOR 73, 74, VENDOR 76].

The technologies identified for further investigation have different technical maturities. The general consensus is that the current 'State of the art' is still activated carbon filtration. In many investigations this has been used as the benchmark to compare and evaluate developing and less mature adsorption technologies [4, 5].

The technologies encompassed in this report were then subject to a detailed search of the published scientific literature to characterise their PFAS removal performance as well as to identify critical process parameters (e.g. amount of residuals, energy consumption etc.).

Peer-reviewed literature was screened using the search engines Science Direct and Google Scholar. Since PFAS treatment is a relatively recent research topic, no date limits were set. The following keywords were used:

['name of the technology']

1. AND removal AND PFAS OR perfluorinated alkylated substances OR single substance acronyms (e.g. PFBS, PFBA, PFOS, PFOA)
2. OR field study OR application OR implementation

['PFAS' OR 'perfluorinated alkylated substances']

1. AND remediation
2. OR treatment
3. OR removal from water

Using this approach it was apparent that the technical maturity of the different remediation technologies significantly influenced the number of 'hits'.

For well-established technologies that have already been demonstrated under pilot- or full-scale conditions the results are thoroughly discussed in peer-reviewed literature and the search gave a large number of hits. In these cases the papers were quickly scanned by reading the abstract to select the relevant studies for a more detailed survey.

The search resulted in fewer hits for some technologies that have been tested mainly at laboratory or bench scale. However, the results that were discussed in peer-reviewed literature yielded sound performance data.

For some very recent technologies, the publicly available data was limited to technical information provided by the vendor or conference presentations. In many cases, the lack of field-proven results and peer reviewed literature impeded a detailed validation of the technology. Therefore, vendors were contacted and additional technical information about the product performance or ongoing field studies was requested. Depending on the quality of the data provided, the references were discussed in personal phone calls or via email contact. The reviewed data achieved from product brochures or presentations by the vendor a reference is cited as [VENDOR [reference]]. The information directly achieved from the vendor via email or phone call is marked in the text as [VENDOR].

Besides the search engines for peer-reviewed literature, the cited literature from the publications was scanned for relevant data as well as topic-related literature provided by the search engine.

In total, about 70 peer-reviewed papers and 65 reports, conference papers, technical regulations, book chapters and technical fact sheets from the vendors were included in the literature research.

Due to differences in the process design, removal mechanisms and fate of PFAS during the treatment, the technologies are subdivided into the following four groups:

- Sorption technologies ;
- Flocculation technologies ;
- Liquid-liquid separation technologies and
- Destruction technologies

3. PER- AND POLYFLUOROALKYL SUBSTANCES (PFAS)

3.1. OVERVIEW

Per- and polyfluoroalkyl substances (PFAS) are anthropogenic substances with hydrophilic and hydrophobic properties. Due to these characteristics, they are both oil and water repellent and have been used in a wide range of industrial and household products since decades. The chemical group of PFAS comprises a large number of individual substances with different characteristics regarding e.g. their physical properties and their toxicity [9].

Perfluorinated compounds are (mainly aliphatic) hydrocarbons where all hydrogen atoms of the aliphatic chain have been replaced by fluorine atoms (c.f. chemical structures of PFAS in **Figure1** [1]). If only a part of the hydrogen atoms has been replaced by fluorine, the resulting compounds are denoted as polyfluorinated substances. The group of PFAS can be further subdivided into per- and polyfluoroalkyl carboxylic acids (PFCA) and per- and polyfluoroalkyl sulfonic acids (PFSA). Regarding their chemical nomenclature, the last letter of the abbreviation indicates an acid (A) or a sulfonic acid (S). The length of the alkyl chain is defined by the third (or the third and the fourth) letter, where Latin prefixes are used. For instance, PFHpS stands for perfluoroheptane sulfonic acid.

A broad family of PFAS exists with different chemical structures at the non-fluorinated part of the molecule. One article about PFAS terminology identifies 40 chemical classes of PFAS and more than 250 individual substances (without considering any unknown PFAS due to proprietary reasons) [9]. In total, PFAS potentially encompasses thousands of individual substances [10, 11, 12].

Figure1. General chemical structure of some classes of PFAS [1]

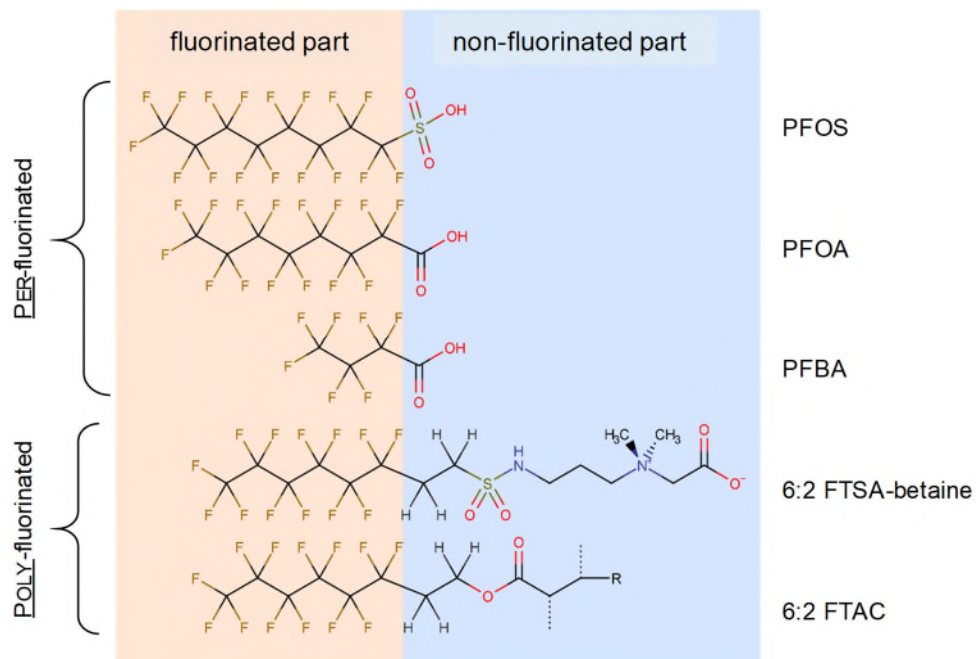
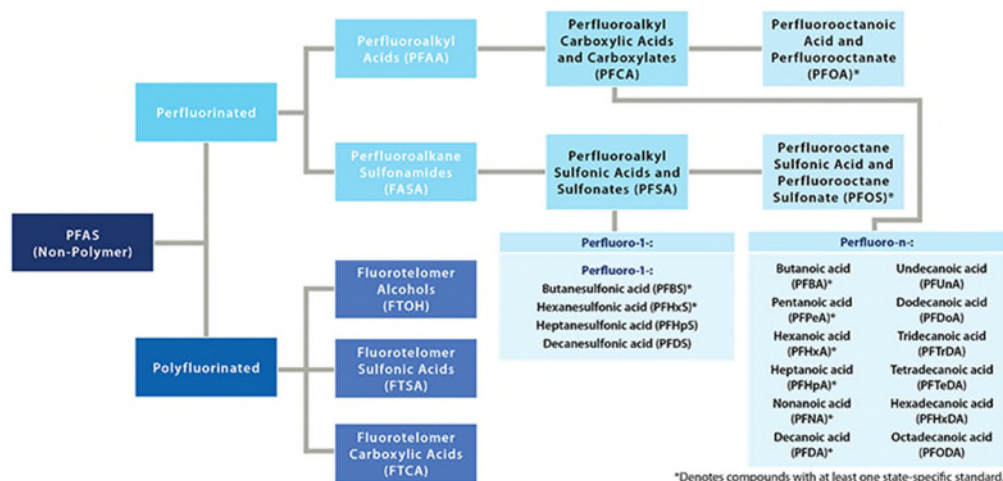

Figure 2. PFAS Family tree [13]



An overview of the division of PFAS into different subgroups is provided in Figure 2 [13].

Furthermore, the group of PFAS can be subdivided into short-chain and long-chain substances. For fluorinated sulfonic acids (PFSA) and fluorinated carbonic acids (PFCA) the following long- and short-chain subdivision is common [14]:

- Long-chain alkyl sulfonic acids (6 and more carbon atoms, e.g. PFOS);
- Short-chain alkyl sulfonic acids (5 and less carbon atoms, e.g. PFBS);
- Long-chain alkyl carbonic acids (8 and more carbon atoms, e.g. PFOA) and
- Short-chain alkyl carbonic acids (7 and less carbon atoms, e.g. PFBA)

In terms of the chemical structure of the non-fluorinated part of PFAS, abbreviations such as FTSA (fluoro-telomere sulfonic acid) or FTAC (fluoro-telomere acrylate) are used for polyfluorinated telomeres. Due to microbial activity, the non-fluorinated part of these substances might be degraded leading to the formation of short-chain PFCA. Therefore, these compounds are specified as precursor substances. Most of these precursors cannot be determined analytically, mainly because of the lack of analytical reference material. However, analysis of surrogate parameters like AOF (adsorbable organically bound fluorine) or application of the TOP assay (total oxidizable precursor) may provide further information about the concentrations of precursors [23].

At neutral pH range, PFCA and PFSA exist as anions containing negatively charged carboxyl (COO^-) and sulfonate (SO_3^-) groups, respectively. The non-fluorinated part of more complex PFAS can contain both, positively charged and negatively charged functional groups. Thus, precursors might exist as anions or as cations. If they possess both, anionic and cationic groups, they are termed as zwitterions [34].

One of the most known PFAS, perfluorooctane sulfonic acid (PFOS), is very persistent and strongly tends to bioaccumulate. Therefore, its usage in the EU is strictly controlled and essentially forbidden since 2006 [15]. In 2009, PFOS was added to the annex of the Stockholm Convention on persistent organic pollutants [16]. For the same reasons, the use of PFOA (perfluorooctanoic acid) is also strictly limited [17, 18]. As a consequence, short-chain PFAS or partly fluorinated fluorotelomers are now used as alternatives for many applications [19 - 21].

In the European Water Framework directive (WFD) priority hazardous substances have been defined. The respective list contains PFOS and PFOS related compounds. EU directive 2006/122/EC on the restrictions on the marketing and use of perfluorooctane sulfonates assigns all *derivatives* of PFOS as relevant substances, including precursor substances [15].

3.2. TOXICOLOGICAL THRESHOLD VALUES

In general, short-chain PFAS are less toxic than longer chained PFAS. However, they are more mobile in groundwater than long-chain PFAS and thus spread quicker in cases of soil contamination [22]. A thorough review of the PFAS regulations is provided in the Concawe report 8/16 [23] and threshold values are listed in Interstate Technology and Regulatory Council (ITRC) fact sheets [24].

For example, the German Environmental Protection Agency (Umweltbundesamt - UBA) published substance specific health-oriented target values for individual PFAS, which are listed in **Table 1** [25]. These values illustrate that PFAS with longer chain lengths are more health relevant than short-chain PFAS. For instance, the guidance value of the C4 compound PFBA (10 µg/L) is one hundred times higher than the value of the C8 compound PFOS (0.1 µg/L).

Table 1. Substance specific health-oriented target values for PFAS in Germany [25]

PFAS		Target value, µg/L ³
PFBA	Perfluorobutanoic acid	10
PFPeA	Perfluoropentanoic acid	3
PFHxA	Perfluorohexanoic acid	6
PFHpA	Perfluoroheptanoic acid	0.3
PFOA	Perfluorooctanoic acid	0.1
PFNA	Perfluorononanoic acid	0.06
PFDA	Perfluorodecanoic acid	0.1
PFBS	Perfluorobutane sulfonic acid	6
PHHxS	Perfluorohexane sulfonic acid	0.1
PFHpS	Perfluoroheptane sulfonic acid	0.3
PFOS	Perfluorooctane sulfonic acid	0.1
PFOSA	Perfluorooctane sulphonamide	0.1
6:2 FTSA	6:2 Fluorotelomer sulfonic acid	0.1

In addition to these toxicology-based values, parametric values for drinking water of 0.1 µg/L for individual PFAS and of 0.5 µg/L for the sum concentration of all PFAS have been published in a proposal for the revised European drinking water guideline from the European Commission [26].

In the USA, the US-EPA published a lifetime Health Advisory level for the sum concentration of PFOS and PFOA which was set at 0.07 µg/L [27]. This value is slightly lower than the one proposed in the EU or in Germany.

However, the most stringent concentration value, which is based on ecotoxicological and environmental considerations, is the environmental quality standard (EQS) for PFOS for inland surface waters (e.g. rivers and lakes) of 0.00065 µg/L (0.65 ng/L) as published in the annex to the EU Water Framework Directive. This is significantly lower than the drinking water limits mentioned above [28] and, as noted in chapter 3.1, this value applies to PFOS and all its derivatives and precursors.

3.3. INGREDIENTS OF FIREFIGHTING FOAMS

Among the most important fields of application of PFAS is their use in Class B firefighting foams. In principle, firefighting foams are subdivided into two classes: Class A foams to fight against wildfires or structure fires and Class B foams that are designed for combustible liquids and gases [24]. Some of the Class B foams produce an aqueous film that spreads across the burning surface of the combustible liquid and quenches the flames. These foams are termed as aqueous film-forming foams (AFFF). Other types of Class B foams exist with and without PFAS [23].

The first generation of AFFF were manufactured with PFOS and PFOS-based precursors that could be transformed to PFOS or short-chain PFSA, e.g. PFHxS. In the United States, the production of this type of AFFF stopped in 2002 due to an increasing awareness of the toxicity of PFOS [29].

Evolving regulations targeting PFOS and later all long-chain PFAS forced the use of alternative ingredients during the production of firefighting foams [31]. A second generation of aqueous film-forming foams predominantly contained fluorotelomer-substances that are potentially transformed to PFOA and other PFCA (but not PFOS). Main precursors were based on a structural element with six C-atoms (C6). Nevertheless, some of the active ingredients were long-chain PFAS and consequently, pProduction of these foams in the US stopped in 2016 [29].

The recent generation of AFFF primarily contain short-chain fluorotelomer-based PFAS. For these substances, there is no risk of transformation into long-chain PFAS such as PFHxS and PFOA. However, foams may still contain trace quantities of PFOA precursors as by-products from the manufacturing process [29].

The specific ingredients of firefighting foams are usually proprietary and therefore not officially published. Analytical investigations of firefighting foam concentrates show that H4PFOS is one of the ingredients with the highest concentration [32]. Its concentration has been identified to be up to 400 mg/L in the foam concentrates. Furthermore, H4PFDS, PFHxA and PFBA have been identified as main ingredients. The comparison of single PFAS concentrations and analyses using TOP assay during the investigation of four different foams indicates that more than 95% of fluorinated compounds exist in form of precursor substances that cannot be identified with single PFAS analyses. In total, the concentration of individual PFAS after TOP assay treatment reached 11 g/L [32].

In-depth chemical analyses of AFFF further show the existence of different C4-C6 perfluoroalkyl sulfonamides like the ones shown in **Figure 3**. In the environment however, these precursors may be biologically transformed to the corresponding perfluoroalkyl sulfonates (PFBS, PFPeS, and PFHxS) [31, 33].

Figure 3. Identified perfluoroalkyl sulfonamides [31]

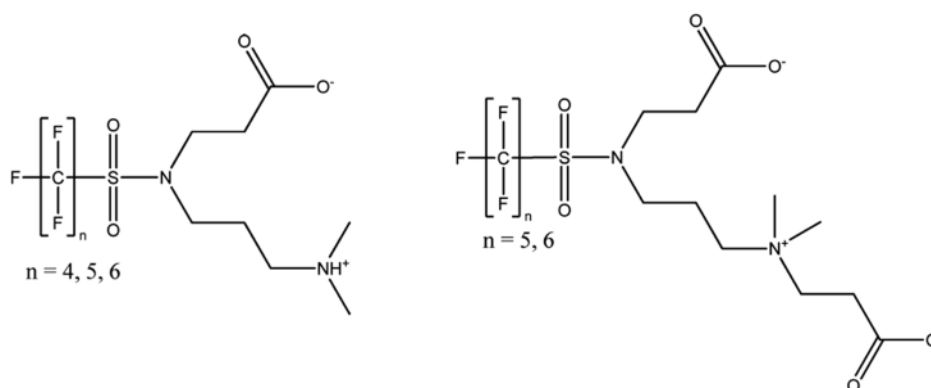

Firefighting foams produced after 2002 contain primarily fluorotelomer sulfonamides possessing a basic chemical structure and different functional groups as shown in **Figure 4**. The various functional groups include methyl, amino, carboxylic acid, thioether, thioamido sulfonate, and mercapto alkyl amido groups [31, 34, 35]. In **Figure 4**, R (= residual group) represents the functional groups. In literature even more complex structures of the non-fluorinated parts of firefighting foam ingredients have been suggested [36]. As mentioned above the functional groups may be degraded biologically resulting in fluorotelomer sulfonates with carbon chain lengths of 4, 6, 8, or 10 and two unfluorinated carbon atoms or in C4 to C8 perfluorinated carboxylic acids [33, 35].

Figure 4 General structure of fluorotelomer sulfonamides [31]

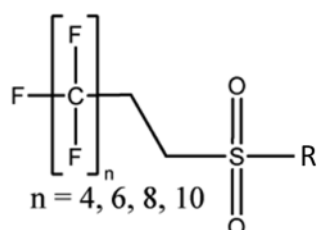

More uncommon fluorinated substances like fluorotelomer **betaines with quaternary amine and carboxylic acid functionalities** (Figure 5) have also been identified in firefighting foams [31].

Figure 5 Fluorotelomer betaines [31]

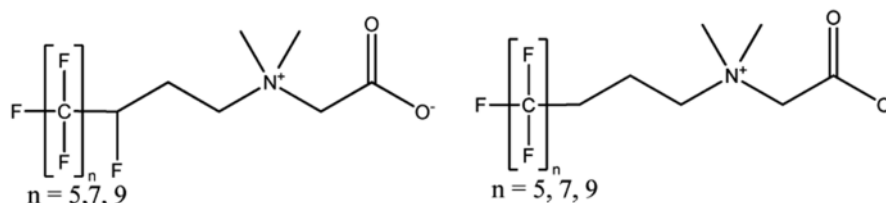

The compounds shown in **Figure 3** to **Figure 5** cannot be quantified currently via analytical standard methods. Their structural identification has been carried out during research projects, but with poor analytical sensitivity. In terms of characterization of contaminated groundwaters or fire-extinguishing waters, these analytical methods are usually not appropriate. Other possibilities to characterize the PFAS precursors are the determination of the surrogate parameter AOF (adsorbable organically bound fluorine) [37] or applying the TOP assay (total oxidizable precursor) [38] (see chapter 3.1).

As a rule, even by analysing firefighting foams with comprehensive analytical methods of commercial laboratories, only a small part (less than 10%) of the total organofluorine content can be explained by individual fluorochemicals [32, 35]. Most of the ingredients remain unknown.

Besides PFAS, other components like organic solvents (e.g. trimethyl-trimethylene glycol and hexylene glycol), foam stabilizers (e.g. lauryl alcohol), and corrosion inhibitors are integral parts of firefighting foams [39].

3.4. COMPOSITION OF PFAS CONTAMINATED GROUNDWATERS

PFAS contaminations of soil and groundwater are present worldwide due to the widespread use of PFAS in a variety of applications. Main point sources include historic industrial discharges, from firefighting incidents, wastewater treatment plant effluent, landfills and fire-fighting training grounds. In many cases, the predominant contaminant is still PFOS [40, 41]. Since firefighting foam formulations have changed over time, the mixture of PFAS found in the environment may vary significantly, depending on the specific site. In particular, short-chain PFAS have been part of these mixtures for a long time. However, short-chain PFAS may also occur in groundwater due to other contamination events, for example due to illegal disposal of paper-making waste [1, 42].

Precursors are less water soluble and tend to adsorb more on soil than PFCA or PFSA. Consequently, they tend to remain at the source area of the contamination and migrate less into the groundwater. They can degrade biologically to more persistent perfluorinated compounds, although degradation rates are poorly documented [4, 23].

Due to dilution with uncontaminated groundwater or rainwater, the concentration levels of PFAS that are found in the groundwater are in general much lower than in the original AFFF [4, 23].

3.5. COMPOSITION OF FIREFIGHTING WATERS

Firefighting waters are collected during and after firefighting events. Due to a lack of time, the precursors are usually not transformed into other PFAS [38]. Thus, the composition of firefighting wastewaters is nearly the same as a diluted AFFF used for fire extinguishing.

Ultimately, the composition of firefighting waters depends on the firefighting product used. **Table 2** gives an example of the composition of a firefighting water containing about 3% of a “PFOS-free” firefighting foam. It is evident that in this foam a variety of PFAS can still be detected and quantified. The major component that was identified is H4PFOS, which is the same as 6:2 fluorotelomer sulfonic acid [TZW measurement].

Other ingredients that can be expected include dirt and organic matter due to the contact of the water with the ground. Consequently, algae growth may be expected to occur if the extinguishing water is stored over a longer period.

Table 2 Example of PFAS composition of a firefighting water [TZW measurement]

PFAS		Concentration, $\mu\text{g}/\text{L}^3$
PFBA	Perfluorobutanoic acid	0.5
PFPeA	Perfluoropentanoic acid	0.3
PFHxA	Perfluorohexanoic acid	2.1
PFHpA	Perfluoroheptanoic acid	0.9
PFOA	Perfluorooctanoic acid	1.6
PFNA	Perfluorononanoic acid	0.01
PFDA	Perfluorodecanoic acid	0.1
PFUnA	Perfluoroundecanoic acid	< 0.001
PFDoA	Perfluorododecanoic acid	0.01
PFBS	Perfluorobutane sulfonic acid	< 0.001
PFPeS	Perfluoropentane sulfonic acid	< 0.001
PHHxS	Perfluorohexane sulfonic acid	0.01
PFHpS	Perfluoroheptane sulfonic acid	< 0.001
PFOS	Perfluorooctane sulfonic acid	1.4
PFOSA	Perfluorooctanesulfonamide	0.06
HPFHpA	7H-Dodecafluoroheptanoic acid	< 0.001
H2PFDA	2H,2H-Perfluorodecanoic acid	< 0.001
H4PFUnA	2H,2H,3H,3H-Perfluoroundecanoic acid	< 0.001
H4PFOS	1H,1H,2H,2H-Perfluorooctane sulfonic acid	86

Note: Since 2011 firefighting foams are free of PFO

4. APPROACH OF TECHNOLOGY EVALUATION

4.1. TREATMENT SCENARIOS

The treatment efficiency for an individual technology always depends on the water matrix, the treatment goal and on the specific substances which are to be removed [3, 5, 8]. Therefore, in the following Sections the specific PFAS of interest, their initial concentrations, different water matrices (that might cause possible negative side effects on PFAS removal) and target concentrations are defined.

In general, two different treatment scenarios are considered.

1. If PFAS contaminated groundwater is remediated, large volumes of water have to be treated for a long period. In principle, groundwater treatment can be performed *in-situ* via application of a remediation approach within the contaminated soil or *ex-situ* following a *pump-and-treat* process and using an on-site treatment technology. The current practise for PFAS is currently *ex-situ* as there are no commercially proven *in-situ* methods available [4].
2. If firefighting water is treated, the amount of water is limited to some hundreds or thousands of cubic metres (m³). In this case, the whole volume of contaminated water may be treated by a mobile treatment plant within several days or weeks. As extinguishing water is collected from building and terrain surface runoffs, it is expected that it will contain dirt and organic matter and algae might grow over time.

4.2. PFAS OF INTEREST

Since PFOS and PFOA are the compounds that are mostly monitored in studies that investigate the removal of PFAS from water, the evaluation of treatment technologies is mainly based on the removal efficiency for these two substances.

In addition, the treatment success for other long-chain and short-chain PFAS (c.f. chapter 3.1 for definition) is considered within this report. As far as information was available, the effect of the treatment on fluorine-specific surrogate parameters such as TOP assay and AOF is also included.

4.3. INITIAL PFAS CONCENTRATIONS AND WATER MATRIX

To distinguish between the treatment of contaminated groundwater and collected firefighting water, initial PFAS concentrations were estimated to be about 2 mg/L for firefighting wastewaters and between 10 and 100 µg/L for contaminated groundwaters. These concentration levels refer to the sum of all PFAS present within the contaminated water.

As mentioned before, firefighting foams include organic surfactants, organic solvents, and organic foam stabilizers, leading to a high load of organics in the firefighting wastewater. To account for the presence of organic substances within the technology validation, a high concentration of dissolved organic carbon (DOC) of up to 1,500 mg/L is considered for treatment of fire fighting wastewaters. Although the chemical and biochemical oxygen demand (COD, BOD) are also very high in wastewaters these will be dependent on the nature of the DOC and are not included into the evaluation as specific parameters.

In addition, the influence of conductivity and the presence of ionic constituents like sulphate on the treatment result is evaluated. For groundwater, the range is defined from 50 $\mu\text{S}/\text{cm}$ for low mineralized waters to 2,000 $\mu\text{S}/\text{cm}$ for highly mineralized waters and a sulphate content from 10 to 250 mg/L. In case of firefighting wastewaters, the conductivity will be much higher than in groundwater. pH values of groundwaters and firefighting waters are very often in the neutral range between 6 and 9. In some cases, groundwaters are slightly acidic and pH reaches values down to 4. **Table 3** summarizes the main water matrix components considered in this report and the parameter ranges used for the technology evaluation.

Table 3 Water composition of groundwater and firefighting waters

	Groundwater	Firefighting water
PFAS	10 - 100 $\mu\text{g}/\text{L}$	2 mg/L
DOC	1 - 10 mg/L	up to 1,500 mg/L
Conductivity	50 - 2,000 $\mu\text{S}/\text{cm}$	> 500 $\mu\text{S}/\text{cm}$
Sulphate	10 - 250 mg/L	10 - 250 mg/L

Firefighting waters and contaminated groundwaters from oil and gas refineries might also contain petroleum compounds. Therefore, the influence of such substances was assessed by taking the surrogate parameter TPH (total petroleum hydrocarbons) into account.

4.4. TREATMENT GOALS

No discharge limits have been set for PFAS in the EU. In order to assess whether discharges can result in exceedances of EQS values, the Working Group E developed a technical guideline on Chemical Aspects working under the umbrella of the Common Implementation Strategy supporting the implementation of the Water Framework Directive. This technical guideline presents a tiered assessment to evaluate discharges and shows that compliance with thresholds will depend on site specific conditions, including the type and flow of the receiving water body (rivers, lakes, estuary) as well as the discharge flow and the load of pollutants [43]. This explains why no generic discharge criteria have been developed but as a Priority Hazardous Substance (PHS) measures should be put in place to eliminate and cease discharge.

In order to have a comparison of technologies, these have been evaluated regarding their ability to achieve the following water quality criteria:

- 0.07 $\mu\text{g}/\text{L}$ for the sum of PFOS and PFOA (US-EPA) [27];
- 0.1 $\mu\text{g}/\text{L}$ for individual PFAS and 0.5 $\mu\text{g}/\text{L}$ for the total PFAS content (proposed EU drinking water limits) [26];
- Target values according to health-based data (set by the German EPA) [25]
 - PFHpA: 0.3 $\mu\text{g}/\text{L}$
 - PFPeA: 3 $\mu\text{g}/\text{L}$
 - PFHxA: 6 $\mu\text{g}/\text{L}$
 - PFBA: 10 $\mu\text{g}/\text{L}$
 - PFBS: 6 $\mu\text{g}/\text{L}$

It should be noted that the EU Environmental Quality Standard (EQS) for PFOS and its derivatives is 0.00065 µg/L (0.65 ng/L). The EQS refers to the concentration in the receiving water after dilution of the discharge [28]. Therefore, depending on the flow rate of the receiving water and the prevailing background levels, this criterion might be the most relevant one for the site specific treatment goal.

4.5. EVALUATION CRITERIA

To provide a valid basis for an evaluation of the different treatment technologies, the following items have been addressed as far as it was possible from available literature:

- Removal efficiency for PFAS

The removal efficiency for different PFAS is the most important criteria indicating the remediation success of the treatment and providing information on whether or not target concentrations are achievable with a single technology. However, for most of the technologies, site-specific conditions may significantly affect the PFAS removal rates and impede a general conclusion regarding the removal efficiency of each technology.

- Pre-treatment requirements

Depending on the water matrix and presence of interfering impurities, a pre-treatment step might be required to ensure that a specific technology can operate efficiently and without undue interference to achieve its designed technical standards.

- Sensitivity to relevant water matrix components

In addition, the removal efficiency for PFAS might be reduced due to co-contaminants in the water matrix. Here, a specific pre-treatment to remove relevant co-contaminants up-stream might be useful to enhance the PFAS removal.

- Limitations of the technologies

Other technology-specific limitations are also considered which might influence the process selection. For instance, a particularly high energy demand or a weak recovery of the treatment process (resulting in a large waste-stream volumes).

- Waste management

Apart from PFAS destruction technologies, the removal of PFAS from water results in a solid or liquid waste-stream that is enriched with PFAS and consequently requires further treatment or disposal to reach a sustainable solution at the end of the treatment process. Hence, disposal routes and the amount of incidental residues are included into the evaluation process.

- Operational costs

Cost drivers during treatment are technology specific and include plant investment costs, material prices of sorption materials, chemical additives, energy costs due to pumping or other energy-intense processes and costs for waste disposal.

5. PFAS REMOVAL TECHNOLOGIES

The list of possible technologies for removing PFAS from water is based on a literature review (see Section 2). Focus of this report was on *ex-situ* technologies because *in-situ* technologies are currently considered to be far from technical maturity and have not demonstrated PFAS destruction or long-term sequestration. *Ex-situ* technologies include established water treatment technologies (e.g. application of activated carbon) as well as recently introduced commercial products with published field or pilot test demonstrations. Further details, including test data, are provided in Section 7 (Case Studies Overview).

As mentioned before, many PFAS treatment technologies concentrate PFAS in a solid or liquid phase (e.g. sorption, flocculation and liquid-liquid separation) while other technologies achieve PFAS destruction (e.g. incineration). While destruction technologies are typically preferred, they generally require higher energy costs [4, 23, 80, 102, 105, 114]. Therefore, in most cases, the ‘concentrating’ technologies are used ahead of the destruction technologies in order to minimize treatment volumes and overall energy demand. Likewise, at a specific site an on-site concentrating technology might be applied with disposal of waste to a centralized off-site facility for destruction [4, 44].

5.1. SORPTION TECHNOLOGIES

Sorption is a PFAS concentrating technology. It can be applied as a stand-alone treatment or as one step in a treatment train. Factors influencing the choice of sorption technologies include operating costs, pre-treatment requirements and management of spent media. Each of these factors depends on the characteristics of the sorbent material with the main treatment parameter being the loading capacity for the target PFAS compound(s) [4, 44].

The most common application of sorbents is in a flow-through fixed-bed filtration column where contaminated water enters the column and PFAS adsorb to the material resulting in a purified effluent [4, 8]. Another less used configuration is the stirred batch reactor containing a sorbent such as powdered activated carbon (PAC) [3]. Downstream of such batch reactors a separation step is established to remove the sorbent from the purified liquid. In either configuration, once the sorbent reaches its maximum loading of the target PFAS compound(s), the spent sorbent is replaced with new or regenerated material [3, 4, 5].

To optimise the operation of these PFAS removal systems, two (or more) sorbent columns might be installed in series. The first column removes the bulk of the PFAS and the second column acts as a polishing filter. Once the first column is saturated, the second column might be switched to be the lead column while new sorbent is loaded into the first column, which is then operated as polishing filter. Likewise, two or more batch reactors might be operated at staggered time intervals to run the entire set in semi-continuous mode [3, 8].

To determine the frequency of replacements, the number of bed volumes (BV) that can be treated prior to breakthrough of the target PFAS compound(s) needs to be determined. This value depends on the target effluent concentrations, influent concentrations, the sorbent loading capacity and the presence of other contaminants that can reduce the PFAS loading capacity of the sorbent. In this report, the throughput of water in bed volumes until a material replacement is required is used as main parameter for the evaluation of adsorption technologies.

While reactor or column volume and flow rate are controlled parameters, the influent PFAS concentration and the presence of other contaminants are variable and site-specific. The time to saturate the sorbent with PFAS tends to be the critical parameter for operating a sorbent treatment system. The loading capacity of the sorbent is usually expressed as mass of sorbed PFAS per unit mass of sorbent. For well-known sorbent/pollutant combinations, the full range of performance is documented in adsorption curves (contaminant load on the sorbent versus concentration in the liquid phase at equilibrium) [45]. Given the recent environmental concerns and interest in PFAS remediation, a variety of existing and newly developed sorbents have been tested. However, not all sorbents have adsorption curves available in the appropriate PFAS concentration range or the adsorption curves have been determined with deionized water without considering any potential adsorption competition. For new products, this lack of information leads to uncertainty when evaluating the technology.

The PFAS loading q of the adsorption material at the time the breakthrough starts can be calculated with the following equation [45]:

$$q = V \cdot c_0 / \rho_F \quad (1)$$

with q = loading of the material (g PFAS / g sorbent)
 V = volume of treated water in bed volumes (BV, m³)
 c_0 = initial concentration in the raw water (mg/l or g/m³)
 ρ_F = filter density (g/m³)

The calculation of the volume that can be treated until breakthrough starts is more complex. For this calculation, the equilibrium loading of the sorbent with PFAS (q_0) relating to a given initial PFAS concentration (c_0) is required. This relationship can be derived from adsorption isotherms. However, experimental isotherm data from using deionized water is not always particularly helpful or relevant in most cases as competing matrix ingredients might have a significant impact on the adsorption process [45, 54, 117, 118]. Once, the relationship between initial concentration c_0 and the relating loading q_0 is known, the treatable water volume until breakthrough can be calculated as follows [45]:

$$V \text{ [BV]} = \rho_F q_0 / c_0 \quad (2)$$

with V = volume of treated water in bed volumes (BV)
 ρ_F = filter density (g/m³)
 q_0 = loading relating to c_0 (g PFAS / g sorbent)
 c_0 = initial concentration in the raw water (mg/l or g/m³)

Sorbents that can achieve higher loading capacities are of course desirable, but often come also at a cost. In addition, other factors may influence the selection of an appropriated sorbent e.g. pre-treatment requirements or vulnerability against specific water matrix components. In particular, pre-treatment is needed to reduce competitive adsorption by other constituents present in the water including suspended solids, organic matter, petroleum compounds, iron and manganese [1, 4].

Pre-treatment to address iron and manganese, such as using silica sand filters after air or oxygen dosing, may be of particular importance and may be required by the drinking water industry when concentrations exceed values of 0.2 mg/L for iron and of 0.05 mg/L for manganese. These constituents can cause excessive fouling of the filter system restricting flow as well as limit sorbent loading capacities. Furthermore, PFAS may accumulate in the iron and manganese sludge requiring

additional management such as back-washing and disposal [44]. In one example, sludge containing PFAS was classified and disposed as hazardous waste resulting in costs of about 500 € per tonne of sludge [44].

Similarly, the requirements to regenerate, treat or dispose the spent sorbent once completely loaded with PFAS should also be considered. The options available depend on the type of sorbent and the availability of offsite treatment and disposal facilities. For the full destruction of PFAS, a post-treatment step of incineration of the spent media at high temperatures (800 to 1,000 °C) may be needed [4].

5.1.1. Activated carbon

5.1.1.1. General description and PFAS removal mechanism

Adsorption of PFAS onto granular activated carbon (GAC) is a field-proven technology that is often used as a cost benchmark [4, 5].

Figure 6 shows a flow diagram of a GAC system including potential pre-treatment and disposal routes of the spent material. When the loading capacity for the target PFAS is reached and breakthrough begins, the GAC has to be replaced with either fresh or thermally reactivated carbon [45, 54, 117, 118]. The Empty Bed Contact Time (EBCT) for an activated carbon filtration system normally varies between 5 and 20 minutes [45]. Typical filter velocities (v_f) during operation are between 5 and 15 m/h. These design parameters along with the dimensions of the filter vessel and influent PFAS concentrations can be used to determine when a carbon replacement may be needed [120, 121].

Figure 6. PFAS flow diagram for adsorption filtration with activated carbon

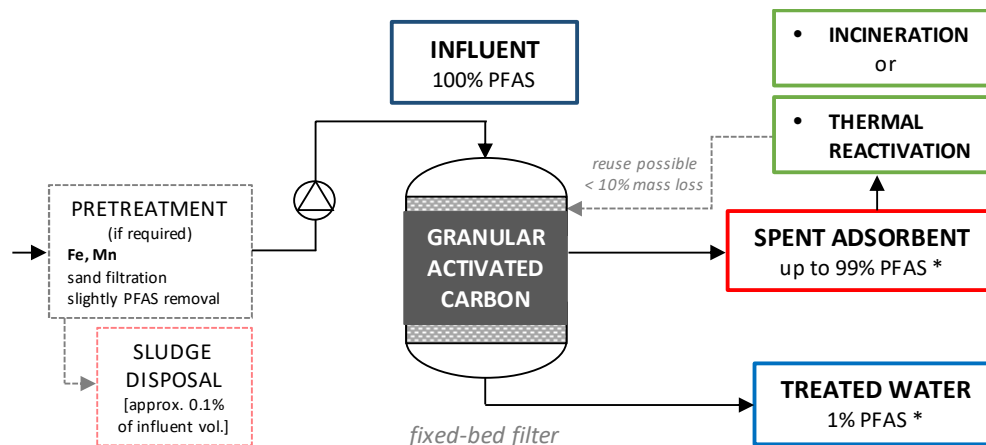

* 1 % of PFAS in the filter effluent seems to present a typical value for a PFAS mixture of different substances with differing absorbance properties.

5.1.1.2. PFAS removal efficiency and costs

Removal efficiencies (with variations up to $\pm 50\%$) strongly depend on the type of activated carbon used [44, 116].

In groundwater applications operation times until breakthrough occurs for most PFAS is between 20,000 to 40,000 BV [120, 121]. According to equation (1), this corresponds to loadings of 10 to 60 mg/kg.

Groundwater treatment costs for different PFAS currently range from 0.04 to 0.20 € per m³ for long-chain and short-chain PFAS, respectively. These values are based on operation times of 8.000 to 40.000 BV (corresponds to operating times of 20 to 100 m³/kg assuming a bulk density of 400 kg/m³) and activated carbon costs of 4 €/kg.

A PFAS removal rate of 99.9% has been documented for a fire-extinguishing water treated by granular activated carbon [46]. However, this elimination rate has been determined after a very short operation time. The maximum operation time until material exhaustion has not been reported. While higher influent concentrations would lead to higher loadings of PFAS onto the carbon, the presence of numerous co-contaminants may lead to a reduction in the loading due to competitive sorption [4, 45, 46].

The US-EPA Health Advisory level for PFOS and PFOA (0.07 µg/L) as well as the proposed EU drinking water threshold of 0.1 µg/L for individual PFAS components (0.5 µg/L for total PFAS) are achievable by activated carbon treatment [1, 3, 46, 120, 121], but may require the use of several beds in series.

5.1.1.3. Sensitivity to water matrix components

In general, decreasing water temperature can lead to an increase in adsorption rates [45]. However, temperatures in the range expected for groundwater and firefighting wastewater are not expected to affect the performance significantly [45]. This is similarly true for the water conductivity and pH [45].

5.1.1.4. Pre-treatment requirements and residue management

Activated carbon possesses an affinity for most organics, including petroleum hydrocarbons. Hence, it will absorb many compounds besides PFAS. Competitive effects to PFAS adsorption have been observed for organochlorine compounds, benzene, toluene, xylenes (BTX), polycyclic aromatic hydrocarbons, and other petroleum substances [44]. If present, these dissolved organic compounds can increase material costs [44, 3, 47] and pre-treatment may be cost effective.

Pre-treatment may also be required for iron or manganese and suspended solids, depending on their influent concentrations. While they may not prevent PFAS adsorption, they may lead to filter clogging and may reduce effective operational capacities. Further, for an influent turbidity higher than 1.5 FNU, particle elimination is recommendable to prevent pressure loss during filtration and hence frequent filter rinsing [46].

Activated carbon vendors typically offer management options for their spent sorbent. Spent activated carbon can be thermally reactivated or incinerated [4]. When considering carbon reactivation, the regeneration process may hold the risk of hydrofluoric acid formation, requiring capture and neutralization of the acid in a scrubber. If the temperatures required to reactivate the carbon are insufficient to mineralize the PFAS completely, incineration might be the recommended disposal route. In either case, it is expected that air emission treatment may be required at the treatment facility. Another option is off-site disposal of the spent material. However, it can be expected that leachate management may be a concern for this option, however no systematic review of leaching of disposed GAC was found in the literature review.

5.1.1.5. Case studies

There are numerous case studies of full-scale applications across the world. See Section 7.1 (Case Studies Overview).

5.1.1.6. Knowledge gaps

The optimum combination of PFAS treatment technologies in a treatment train is an area of further research for all technologies. For example, activated carbon treatment can be a polishing step after flocculation or a pre-treatment step before other adsorption steps e.g. ion exchange.

To forecast the operation time until exhaustion, site-specific pilot testing is typically required to consider the impact of the present PFAS mixture and potentially co-contaminants.

5.1.2. MatCare

5.1.2.1. General description and PFAS removal mechanism

MatCare is a commercially available adsorbent developed by the Cooperative Research Centre for Contamination Assessment and Remediation of the Environment in Australia (CRC Care). Raw material for the adsorbent is the organoclay mineral palygorskite, which is chemically altered with aliphatic amines, resulting in a hydrophobic surface character. The main constituents of palygorskite are magnesium and aluminium silicate [VENDOR 48, 49]. The adsorbent is available as granular medium.

The removal of PFAS by MatCare is based on the hydrophobic interactions of the carbon chain of a PFAS molecule and the surface of the adsorbent material [49]. In addition, electrostatic interactions between the anionic part of a PFAS molecule and unmodified parts of the organoclay may also contribute to the overall affinity [49].

Figure 7 shows a flow diagram for the MatCare technology including potential pre-treatment requirements as well as disposal routes.

Figure 7. PFAS flow diagram for adsorption filtration with MatCare.

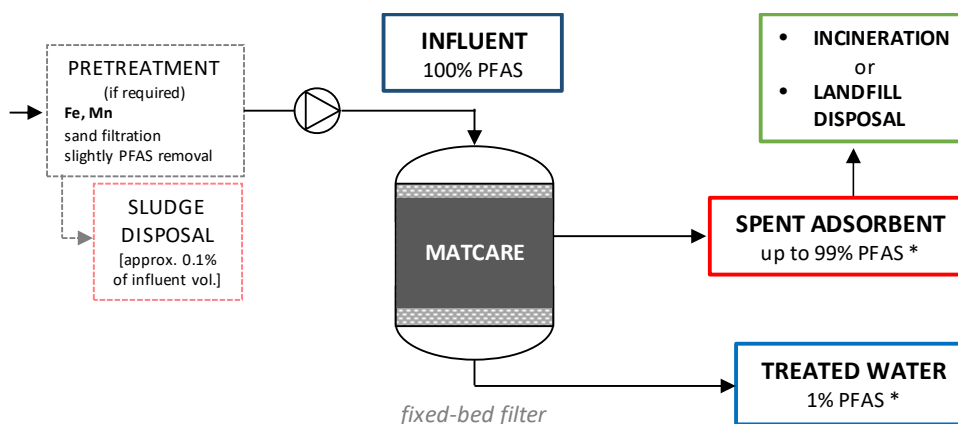

* indicative value based on lab-scale experience; removal efficiency and target PFAS concentrations strongly depend on PFAS components to be removed and site-specific conditions (e.g. influent concentration, presence of competing substances, etc.)

5.1.2.2. PFAS removal efficiency and costs

The practical experience on the effectiveness of this technology is limited but it has shown to remove long-chain alkyl sulfonates and long-chain alkyl carboxylates (e.g. PFOS, PFOA) as well as some precursor substances from groundwater or fire-fighting wastewater [VENDOR 50, VENDOR 122]. In addition, vendor has recently claimed complete removal of short-chain PFAS [VENDOR].

The limited published data regarding the sorbent loading is often derived from lab tests with a synthetic water matrix containing long-chain PFAS. The available literature presents adsorption curves that are more favourable than activated carbon [49]. These data indicate a capacity of 3% to 5% (weight/weight) for a PFAS influent concentration characteristic for firefighting wastewater. However, the curves cover concentrations that are higher than expected for a typical PFAS contaminated groundwater. Therefore, it remains currently open whether MatCare outperforms activated carbon at lower concentrations. However, vendor has recently claimed suitability for groundwater treatment [VENDOR].

For groundwater treatment, no experimental values for achievable operation times are currently available. For PFOS, an operation time of 6,000 BV could be derived from equilibrium data [49]. However, this value should not be considered as reliable due to a high discrepancy of experimental conditions and lack of a realistic water matrix.

In treating a firefighting wastewater, the available data suggest that MatCare can achieve a PFAS removal of 99% [VENDOR 50].

The US-EPA Health Advisory levels for PFOS and PFOA (0.07 µg/L) as well as the proposed EU drinking water threshold of 0.1 µg/L for individual PFAS compounds (0.5 µg/L for total PFAS) are achievable with MatCare, but may require the use of several beds in series [VENDOR 50, VENDOR 122]. However, the effectiveness for water with low concentrations of PFAS is currently undisclosed.

5.1.2.3. Sensitivity to water matrix components

MatCare is expected to exhibit the same sensitivities as activated carbon (see Section 5.1.1.3). Vendor have conducted work to address sensitivity to water matrix components, but it is not disclosed [VENDOR].

In general, organoclay is also used to remove oil from wastewater [136]. Therefore, it is possible that MatCare would be particularly suited to treat oily firefighting wastewater.

5.1.2.4. Pre-treatment requirements and residue management

Pre-treatment and spent sorbent considerations are similar to those for activated carbon (see Section 5.1.1.4). The spent material is typically not reactivated, but is incinerated or disposed to a landfill site [VENDOR].

5.1.2.5. Case studies

There are a few laboratory and pilot-scale studies available (see Section 7.2). Furthermore, a large-scale treatment plant has been used at the Australian Air Force base.

5.1.2.6. Knowledge gaps

The knowledge gaps for MatCare include:

- the removal efficiency for short-chain PFAS to be more widely verified. However, vendor has recently claimed complete removal of short-chain PFAS;
- adsorption curves for low concentrations of PFAS typical for groundwater treatment to be more widely verified. Adsorption curves have been derived by vendor but are not published;
- sensitivity to water matrix components to be more widely verified. Vendor has conducted work to assess this, but the results of this work are not published;
- the feasible operation times for the treatment of a real water-matrix (e.g. groundwater) under conditions that are relevant to current practices.

5.1.3. RemBind

5.1.3.1. General description and PFAS removal mechanism

RemBind is a commercially available adsorbent material that was developed by the Ziltek Company located in Australia in collaboration with Australian-based Commonwealth Scientific and Industrial Research Organization. The adsorbent is a blend of reagents. The main four components are amorphous aluminium hydroxide, activated carbon, organic matter and the mineral kaolinite. For removal of PFAS, the vendor recommends the product RemBind Plus. The adsorbent is usually applied as fine powder, comparable to powdered activated carbon. RemBind Plus is primarily designed for *in-situ* treatment, but also *ex-situ* application is possible [VENDOR 51].

The removal mechanism of the adsorbent is based on electrostatic interactions due to the surface charge of the mineral components and the organic matter that bind to anionic functional groups of PFAS. In addition, the activated carbon component interacts with the nonpolar per- and polyfluorinated carbon chains of the PFAS [VENDOR 52].

RemBind can be used in two ways: Discontinuously in a batch reactor with subsequent separation of the treated water after a specific reaction period (e.g. sedimentation of adsorbent and decantation of treated water) or continuously in a mixed fixed-bed filter (with silica sand to reduce pressure loss) [VENDOR 51, VENDOR 52]. **Figure 8** gives a schematic diagram for RemBind in continuous operation together with potential pre-treatment measures and disposal routes [VENDOR 51].

Figure 8. PFAS flow diagram for adsorption filtration with RemBind

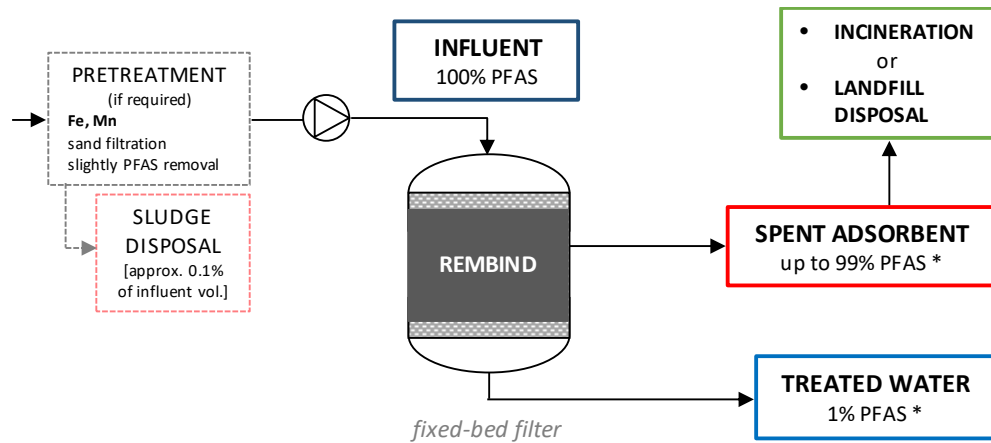

* indicative value based on pilot-scale experience; removal efficiency and target PFAS concentrations strongly depend on the PFAS components to be removed and site-specific conditions (e.g. influent concentration, presence of competing substances, etc.)

5.1.3.2. PFAS removal efficiency and costs

Practical experience is limited to laboratory and pilot studies. However, available data indicate efficient removal of long-chain as well as short-chain PFAS (e.g. PFBS, PFPeA, PFBA) [VENDOR 52].

In continuous treatment of firefighting wastewater, different long-chain and short-chain PFAS were removed to 99.9% and 99.99% within 22 BV [46]. No data are available on the achievable operating time until breakthrough occurs.

In groundwater treatment, no data on operation times have been reported. Only information on loading capacity obtained from isotherm experiments exists [VENDOR 53]. However, from the authors' point of view, these experiments are not suited to predict reliable operation times (cf. Section 0) and should therefore be used with caution.

The US-EPA Health Advisory levels for PFOS and PFOA (0.07 µg/L) as well as the proposed EU drinking water threshold of 0.1 µg/L for individual PFAS components (0.5 µg/L for total PFAS) are achievable with RemBind, but may require the use of several beds in series [VENDOR 51, VENDOR 52]. In this case, however, the energy demand of the treatment line-up will increase to overcome increasing pressure losses.

Treatment costs are dependant on operating time until a material exchange is necessary. Unfortunately, this information is currently not available.

5.1.3.3. Sensitivity to water matrix components

RemBind is expected to exhibit comparable sensitivities to organics as activated carbon (see Section 5.1.1.3).

With respect to petroleum compounds present a TPH content lower than 15 mg/L is considered acceptable for treatment systems using RemBind [VENDOR 53].

According to the vendor, a high salt content does not negatively affect the adsorption efficiency. Experiments with initial PFOA concentrations of 20 ng/L showed no influence of the utilized CaCl₂ concentrations up to 11 g/L, related to a

conductivity of more than 20,000 $\mu\text{S}/\text{cm}$. However, the presence of ionic species in the water might adhere to anionic and cationic functional groups of the adsorbent material thereby reducing the effectiveness of the RemBind [137].

5.1.3.4. Pre-treatment requirements and residue management

Pre-treatment and spent sorbent considerations seems to be comparable to those for activated carbon (see Section 5.1.1.4) with the exception that RemBind is typically not reactivated. Therefore, incineration or offsite disposal of the spent material must be considered when using this technology.

5.1.3.5. Case studies

There are a few pilot-studies available, investigating PFAS treatment of contaminated water (see Section 0).

Additional cases studies are available but not described in this report [VENDOR 138, VENDOR 139]

5.1.3.6. Knowledge gaps

The knowledge gaps for RemBind are:

- operation times for the treatment of groundwater under conditions that are relevant to current practices;
- due to lack of data on operational data (see above) it is not possible to estimate RemBind material replacement times and hence operation costs;
- sensitivity to water matrix components.

5.1.4. Ion exchange (single use or with regeneration)

5.1.4.1. General description and PFAS removal mechanism

Ion exchangers (IEX) are synthetic and polymeric media that have been used in industry and water treatment for many years. In general, they are used for water desalination [4, 55].

At environmental pH values, dissolved PFAS exist as negatively charged molecules and therefore they can adsorb to anion exchangers. Van der Waals forces play an additional role [3, 54, 55], and thus PFAS can be eliminated via anion exchange selectively.

Principally ion exchangers can be utilized in “single-use” or can be regenerated after exhaustion of the adsorption capacity [1, 3, 4, 8]. During the regeneration procedure, the functional groups are transferred into their original form and a further cycle of sorption can be performed. Therefore, the adsorption material does not have to be exchanged but can be used for a number of adsorption cycles. After the regeneration process, the removed PFAS are present in high concentration in the liquid regenerate, which has to be further treated to mineralize the pollutants [1, 8]. Thus, IEX with regeneration represents a liquid-liquid separation procedure as previously described which concentrates the PFAS into a reduced volume of water that has to be treated by another (typically destructive) technology [1, 4, 8].

Figure 9 depicts the flow diagram for IEX application including single-use as well as usage with resin regeneration.

Figure 9. PFAS flow diagram for adsorption filtration with IEX

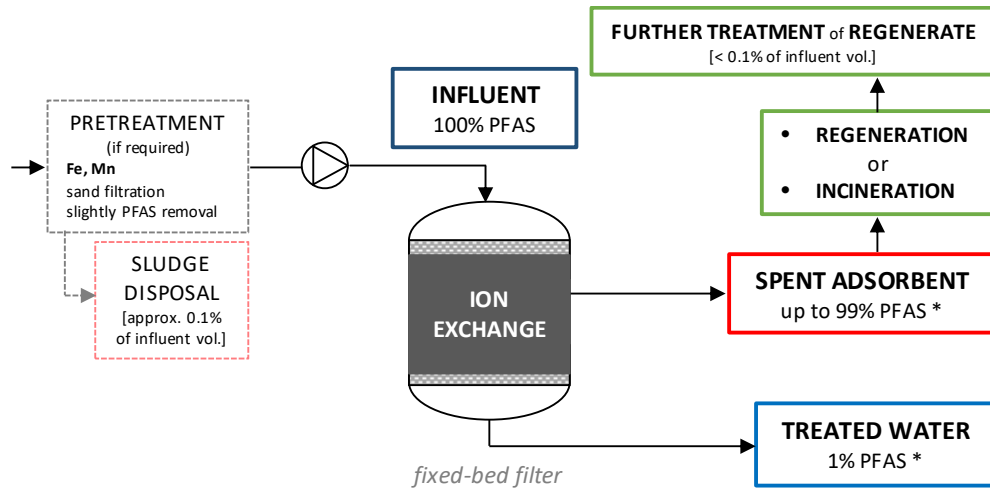

* 1 % of PFAS in the filter effluent presents a typical value for a PFAS mixture of substances with different absorbance properties.

5.1.4.2. PFAS removal efficiency and costs

Various anion exchangers have been identified with a higher adsorption capacity towards PFAS than activated carbons [55, 56, 57, 58]. The selective PFAS removal from contaminated waters by anion exchange works at both high PFAS concentrations of hundreds of mg/L [59, 60] as well as at low concentrations in the ng/L and µg/L range [56].

Similar to the adsorption onto activated carbon, the affinity of per- and polyfluoroalkyl sulfonates (PFSA) to ion exchangers is higher than those of per- and polyfluoroalkyl carboxylates (PFCA) [56], and long-chain PFAS are sorbed preferably compared to short-chain PFAS [3, 56, 57, 123].

Treating groundwater, operation times up to 80,000 to 150,000 BV can be reached for the elimination of long-chain PFAS. However, retention of short-chain PFAS is lower and breakthrough starts at 10,000 to 30,000 BV. [124]

US and EU threshold value for PFOS and PFOA (0.07 to 0.1 µg/L) are achievable using ion exchange resins. [1, 124]

The material costs of ion exchangers are about 12 €/kg, based on the authors' experience, and thus about 3 times higher than the average costs of activated carbon. Using the above information it is estimated that groundwater treatment costs for long-chain PFAS of 0.05 to 0.1 € per m³ and for short-chain PFAS of 0.25 to 0.8 € per m³ respectively.

Treatment costs might be lower when regenerating and re-using the ion exchanger resin [1, 4, 8]. However, for a sufficient regeneration the use of an organic solvent such as methanol or ethanol is required adding to the complexity and cost of this technology [1, 55, 123].

By regenerating a separation factor (volume of PFAS containing water related to the initial volume of water) of 0.1 % to 0.01 % can be reached, depending on the operation time [1].

No references were available for IEX treatment of fire-extinguishing waters or water with PFAS concentrations within the range of fire-extinguishing waters.

5.1.4.3. Sensitivity to water matrix components

Due to competitive sorption, higher amounts of sulphate will result in an earlier break-through of the PFAS and thus in a reduced operation time. At sulphate concentrations of 200 mg/L, negative effects on PFAS sorption have been verified experimentally [57].

A negative influence of pH on PFAS sorption on weak basic anion exchangers (WBA) will occur when the pH value exceeds pH values above pH 7 to 8. As the speciation of PFAS is not affected in the neutral pH range, no pH influence is assumed to occur when using strong basic anion exchangers (SBA) [3].

In general, the presence of organic matter has a negative influence on the operation time regarding contaminant removal [3, 4]. Relating to drinking water treatment, increased concentrations start at approx. 5 mg/L (based on DOC).

5.1.4.4. Pre-treatment requirements and residue management

As is also the case for activated carbon, removal of iron and manganese might be necessary when treating groundwater (see chapter 5.1.1.4). Disposal costs for the hazardous sludge generated from rinsing might be about 500 €/t of sludge [44]. A further particle removal is not expected necessary.

In single-use applications, the IEX resins are loaded with the PFAS and have to be disposed in an approved way. For final destruction of the PFAS high temperature incineration in a hazardous waste incineration operation can be used [4, 8]. It is noted that the IEX resin vendors normally cooperate with specialist licenced waste handling companies that can organise the resin disposal [8].

Promising regeneration treatment technologies include plasma treatment, sono-chemistry, or electrochemical degradation [1, 61] (cf. chapter 5.4). However, when the IEX material is regenerated, the PFAS containing liquid regenerate also has to be treated. This is typically by thermal destruction which is energy intensive and can be an expensive disposal route [4, 8].

5.1.4.5. Case studies

Numerous full-scale applications for groundwater treatment exist worldwide. Examples are given in Section 7.4.

Because of the high adsorption capacity towards PFSA and long-chain PFCA, ion exchange (without regeneration) is used as lag (or sometimes lead) filter in a treatment chain together with activated carbon filtration [4, 8, 62].

5.1.4.6. Knowledge gaps

The knowledge gaps for ion exchange (IEX) technology are:

- Operation times for treatment of fire-extinguishing water that ensure complete removal of the PFAS have yet to be determined. As such it is not possible to estimate of periods for replacement and operation costs;

- most applicable anion exchange resins that show effective PFAS removal over a long period and allow efficient regeneration (preferably without using organic solvents) have to be identified if a reuse of the spent material is required;
- To decrease the operating cost, a further treatment of the PFAS containing regenerate has been suggested and tested. This might be performed via distillation or further adsorption onto ion exchange with very low flow rates.

5.1.5. CustoMem (single use or with regeneration)

5.1.5.1. General description and PFAS removal mechanism

CustoMem is a bio-based adsorbent material that was developed by the company CustoMem in London. The adsorbent material consists of bacteriologically produced nano-cellulose and can be customised (functionalized) during the manufacturing process to adsorb PFAS selectively and to diminish adsorption of co-contaminants [VENDOR 63]. However, the technical maturity of the CustoMem adsorbent is rather low.

The functionalization that is specific for PFAS adsorption is proprietary and hence the exact removal mechanism cannot be described. The adsorbent is available as granular media. When the material is spent, it can be either regenerated on-site (using acidic and/or alkaline aqueous solution) and reused or incinerated [VENDOR]. Figure 10 shows a schematic application of CustoMem for groundwater or firefighting wastewater treatment, including potential pre-treatment and disposal routes of the spent adsorbent.

Figure 10. PFAS flow diagram for adsorption filtration with CustoMem

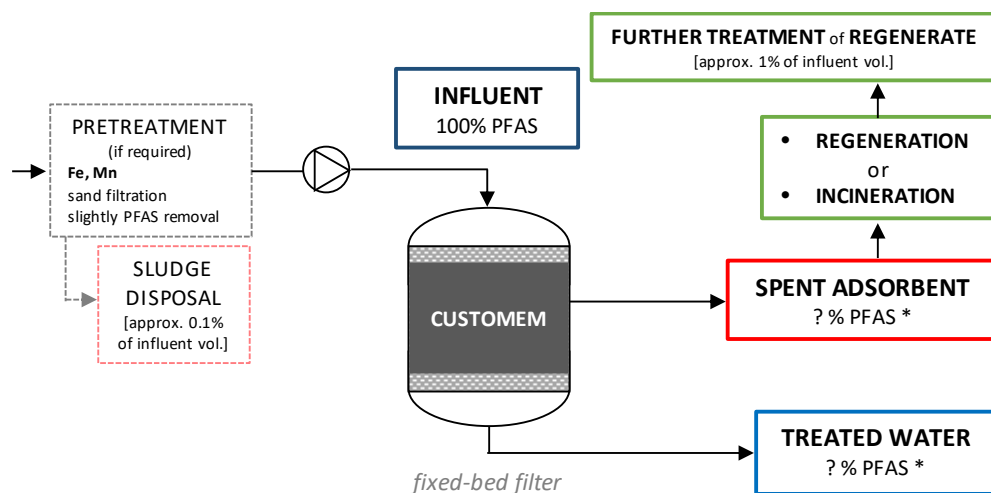

* Removal efficiencies for PFAS are not currently reported in the literature.

5.1.5.2. PFAS removal efficiency and costs

There is no peer-reviewed data about the performance of CustoMem currently available. Furthermore, no experimental data on removal efficiencies for single PFAS are published. However, in laboratory tests CustoMem claims faster adsorption kinetics and larger adsorption capacities than commercially available activated carbon and ion exchange resins. Information on the type of activated carbon and the IEX resin used for the comparison are not provided in the available information [VENDOR 64].

During treatment of contaminated groundwater with PFAS concentrations up to 500 µg/L an operation time of about 700 BV could be achieved before breakthrough occurred [VENDOR].

Due to the lack of detailed information, it cannot be evaluated whether the US-EPA Health Advisory levels for PFOS and PFOA (0.07 µg/L) and the proposed EU drinking water threshold of 0.1 µg/L for individual PFAS (0.5 µg/L for total PFAS) are achievable with CustoMem.

In case of regeneration (with acidic and alkaline aqueous solutions), the concentrate volume is reported [VENDOR] to be one hundred times smaller than the initial volume, meaning there would be a residual volume of about 0.01 m³ concentrate per m³ treated water.

5.1.5.3. Sensitivity to water matrix components

According to the vendor, no significant interferences with a high DOC, a high salt concentration or the presence of petroleum compounds are expected [VENDOR].

5.1.5.4. Pre-treatment requirements and residue management

Pre-treatment considerations regarding the removal of iron and manganese as well as particles are similar to those for activated carbon (see Section 5.1.1.4).

In both single use and regeneration operations the residue management options for CustoMem, are similar to the approaches for residues from ion exchange (see Section 5.1.4.4).

5.1.5.5. Case studies

Currently, there are two field studies at European airports ongoing to treat fire-fighting foam contaminated water with the CustoMem technology [VENDOR 65]. However, the vendor provided no further performance data.

5.1.5.6. Knowledge gaps

The knowledge gaps for CustoMem are:

- the achievable removal efficiencies for different PFAS during groundwater and firefighting wastewater treatment;
- experimental verification of the operation times regarding groundwater treatment. In case of groundwater treatment feasible operation times for a real water matrix should be elaborated;
- the regeneration success and influence of co-contaminants needs to be verified.

5.1.6. Cyclodextrin-based adsorbent (single use or with regeneration)

5.1.6.1. General description and PFAS removal mechanism

Cyclodextrin is derived from cornstarch. Cyclodextrin molecules possess a “cup-shaped” macromolecular structure (diameter in the nm range) and are known to form inclusion complexes (“host-guest”) with many organics. Cyclodextrin-based sorbents are made by cross-linking of cyclodextrin molecules into porous polymers or alternatively the surface of various substrates (e.g. silicate, magnetite or cellulose) can be functionalized with cyclodextrins [66, 67, VENDOR 68].

One company that offers cyclodextrin-based adsorbent for PFAS removal is Cyclopure (USA). The tradename of the adsorbent material that is specifically designed for the treatment of PFAS contaminated water is Dexasorb+. Dexasorb+ is a porous cyclodextrin polymer in which positively charged units are incorporated. It is available in a variety of powder or granular formulations with different particle sizes [VENDOR 69]. Currently, the product is being used in commercial PFAS detection and monitoring applications, and is in pilot evaluation in the U.S. for treatment of PFAS impacted drinking water [VENDOR 69, 140].

The removal mechanism relies on hydrophobic interactions between the inner part of the “cup-shaped” cyclodextrin molecules and the carbon chains of PFAS as well as on electrostatic interactions between the positively charged units and the anionic head groups of the PFAS molecules [VENDOR 69].

Figure 11 shows a schematic flow diagram for the application of cyclodextrin-based adsorbents, including potential pre-treatment and residues management routes. The spent material can be regenerated and reused for further treatment cycles [VENDOR 69].

Figure 11. PFAS flow diagram for adsorption filtration with Cyclodextrin-based adsorbent

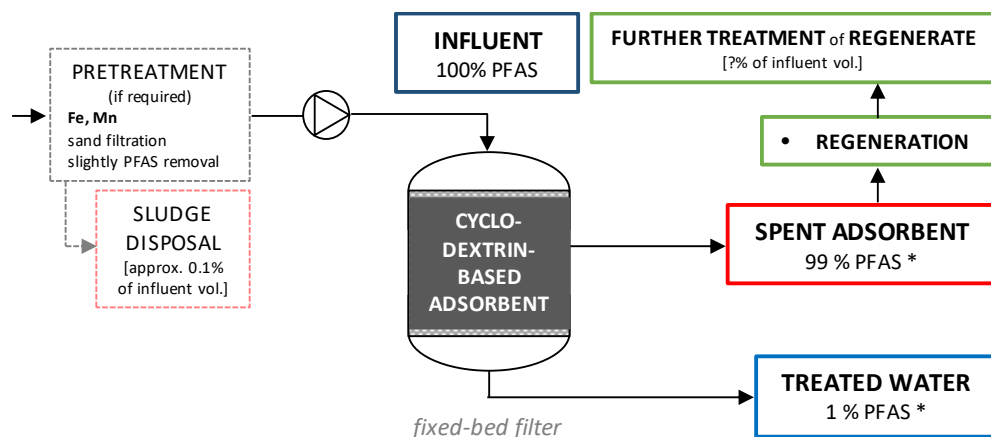

* indicative value based on lab-scale experience; removal efficiency and target PFAS concentrations strongly depend on PFAS components to be removed and site-specific conditions (e.g. influent concentration, presence of competing substances, etc.)

5.1.6.2. PFAS removal efficiency and costs

Published data is limited to laboratory experiments, mainly using demineralized water [66, 67, 70, 127]. The PFAS removal efficiency by DEXSORB+ has also been evaluated with bench-scale batch and RSSCT column experiments across diverse water matrices, from deionized water to groundwater to leachate [140]. Pilot studies and field studies are also initiated under a project in the U.S. [140].

The available experimental data indicate an affinity of the sorbent to long-chain and short-chain PFAS and adsorption experiments suggest faster adsorption kinetics compared to activated carbon [66, VENDOR]. Whereas adsorption equilibrium for most PFAS at environmentally-relevant concentrations can be achieved within 30 minutes using DEXSORB+, several days (or even weeks) can be required for activated carbons to established adsorption equilibrium under similar conditions.

Treating deionized water containing levels of PFOS and PFOA that are comparable to a contaminated groundwater, operation times of 6,300 BV were achieved until break-through occurred [66]. Furthermore, PFAS breakthrough behaviour investigated through column experiments demonstrated the kinetics and capacity of DEXSORB+ for both long-chain and short-chain PFAS in fixed-bed filtration processes. With a real groundwater sample containing 125.1 ng/L PFAS (sum of PFBA, PFOA, PFNA, PFDA, PFBS, PFHxS, PFOS and FBSA), as an example, DEXSORB+ showed a capacity of >55,000 bed volumes for the combined treatment of PFOA and PFOS until breakthrough was observed [VENDOR]

In firefighting wastewater treatment removal efficiencies for different long-chain and short-chain PFAS ranged from 90% to >99%. Hence, cyclodextrin-based adsorbents show a potential to remove PFAS from water effectively [66].

Regeneration can be performed by washing the exhausted material with benign organic solvents amended with a small amount of inorganic salts. After a total of 5 cycles of regeneration, no significant loss of removal efficiency was observed [67, 127]. However, the volume of the regenerate that must be further treated to destroy the residual PFAS in the sorbent cannot be derived from available literature sources.

Lab scale production levels of DEXSORB+ are at an approximate cost of \$20 per kilogram, and expectations are to bring it down to approximately \$15 per kilogram at commercial scale [VENDOR]. From the available information, it is not clear how cost per kilogram relates to €/m³ water.

5.1.6.3. Sensitivity to water matrix components

Where earlier studies with cyclodextrins prior to the development of DEXSORB+ struggled with the impacts of DOC [66], PFAS removal by DEXSORB+ remains consistently high across all tested water matrices (i.e. resistant to fouling), including drinking water, groundwater, surface water, wastewater and even leachate, while the performance of activated carbons degrades significantly in complex water matrices [141].

The resistance of fouling in complex matrices can be attributed to size-exclusion; only low molecular-weight organics, that can fit into the cavity of cyclodextrin, can directly compete with PFAS for the active sites on the DEXSORB+ material, though high levels of inorganic divalent anions (e.g. O²⁻, SO₄²⁻ and S²⁻) can also contribute to the inhibition of PFAS removal by interfering the electrostatic interactions between PFAS and the DEXSORB+ material [141].

Due to the permanent cationic charge of DEXSORB+, it is expected that the PFAS uptake is not affected by change in the pH [VENDOR].

5.1.6.4. Pre-treatment requirements and residue management

Pre-treatment considerations regarding the removal of iron and manganese are similar to those for activated carbon (see Section 5.1.1.4) [VENDOR].

The residue management for cyclodextrin-based adsorbents in both cases, single use and regeneration, offers the opportunity for disposal of isolated PFAS. The separation of adsorbed PFAS enables its further destruction; PFAS concentrates can be isolated from organic solvent for destruction by mechano-chemical processes [142]. The approaches are similar to those of residues from ion exchange (see Section 5.1.4.4).

5.1.6.5. Case studies

There are a few lab-scale studies available where PFAS contaminated groundwater or fire-extinguishing waters have been treated with cyclodextrin-based adsorbents (see Section 7.6).

A pilot study is currently ongoing in the US [140] but it is not described in detail in this report.

5.1.6.6. Knowledge gaps

The knowledge gaps or cyclodextrin-based sorbents based technology include:

- adsorption data for PFAS concentration levels characteristic for groundwater and experimental verification of the impact of co-contaminants.
- data on removal efficiencies towards PFAS and precursors under relevant water matrix conditions.
- For groundwater remediation and treatment of firefighting wastewater, pilot and field studies should be implemented to allow an in-depth evaluation of the performance of cyclodextrin-based sorbents. In particular, feasible operation times with a real water matrix should be investigated.

5.2. PRECIPITATION / FLOCCULATION

Precipitation/flocculation technologies in water treatment are based on the addition of chemicals, normally termed as coagulants or flocculants that aim to remove suspended, colloidal and dissolved substances. The chemical additives are mixed into the water stream to transfer the target compounds in a state that facilitates separation during a subsequent sedimentation, filtration or flotation step. Thus, a flocculation process always requires an additional separation treatment step [8].

For conventional precipitation/flocculation processes in water treatment, iron chloride or aluminium chloride is used as coagulation compound. Main treatment goal is the elimination of particles and turbidity. In addition, dissolved organics and heavy metals might be precipitated and transferred into the sludge [8].

Data from laboratory experiments as well as results derived from large-scale implementations demonstrated that conventional coagulation/flocculation followed by sedimentation or filtration (sand filtration or MF/UF) did not provide an efficient removal of PFAS from water. Common coagulants such as aluminium sulphate, aluminium sulphate combined with polymers as well as polyaluminium chloride were applied in these studies [2, 3, 71, 72]. Only a process where a dissolved air flotation step instead of sedimentation was used demonstrated a removal rate of 49% for PFOS [71]. Other studies using FeCl_3 as coagulant resulted in removal efficiencies of 3% for PFBS, 12% for PFOS, 5% PFHxS and an elimination rate of 4% for PFHpA [72].

To remove PFAS, specific coagulation compounds have been developed that interact with the chemical structure of PFAS and lead to a co-precipitation. In this report, the amount of flocculent in relation to the removal efficiency is used to compare these different coagulants [4, 8].

5.2.1. PerfluorAd

5.2.1.1. General description and PFAS removal mechanism

The PerfluorAd technology from Cornelsen Umwelttechnologie GmbH in Germany is based on a liquid reactant that works in a similar manner to a coagulant or flocculent. The liquid reactant is applied in stirred tank reactors and, in case of very high PFAS concentrations (not specified by vendor) in the raw water and/or simultaneous occurrence of solids or iron, a sedimentation step is added subsequently, followed by a filtration step separates the flocculent from the water (see **Figure 12**). The technology aims to remove the bulk of PFAS to prolong the operation time of a subsequent polishing step, e.g. an adsorptive treatment [4, VENDOR 73, VENDOR]. Hence, PerfluorAd is usually only one part of a treatment train.

In most applications, a sedimentation step is not necessary. For groundwater treatment plants and other water treatment processes, that already applies filtration stage for the separation of iron and/or solids, only the stirred reactor is added when using the PerfluorAd technology [VENDOR].

The removal mechanism relies on electrostatic and hydrophobic interactions between the PerfluorAd reactant and the PFAS [4].

Figure 12. PFAS flow diagram for treatment with PerfluorAd

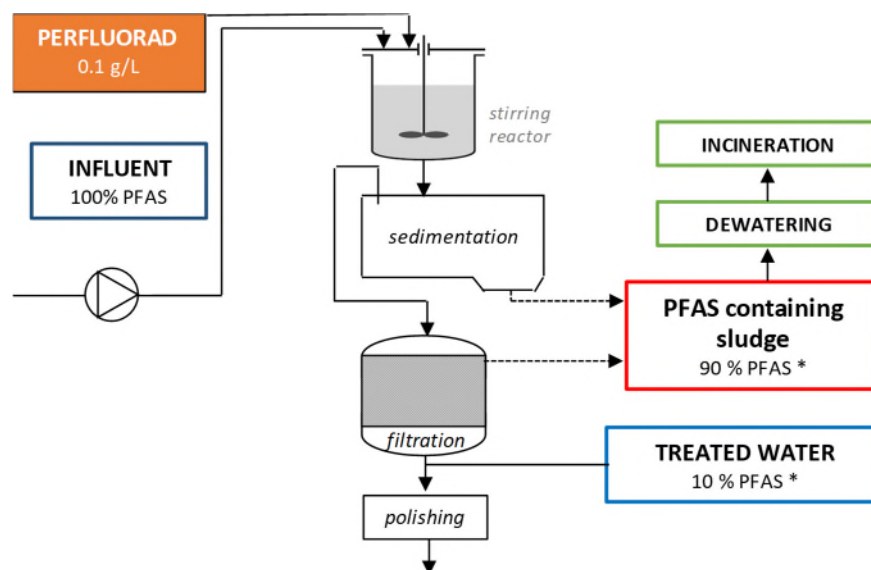

* Removal efficiency for a certain flocculent dosage (0.1 g/L). Higher dosage might lead to higher removal efficiencies.

5.2.1.2. PFAS removal efficiency and costs

The chemical composition of the PerfluorAd flocculent is unknown due to proprietary reasons but according to the vendor, it can be adjusted to optimize the precipitation efficiency for specific PFAS. The dosage ranges from 25 mg/L to 2 g/L and can be optimised for different PFAS concentrations and the water matrix to obtain higher elimination rates. Principally, it is designed for treating water containing PFAS concentrations greater than 0.3 µg/L [4].

Treating groundwater, a dosage of 100 mg/L PerfluorAd removed PFOS, PFOA and PFHxS with an elimination rates $\geq 90\%$. PFPeA was only removed up to 40%. When the dosage was increased to 200 mg/L, the removal efficiency for PFPeA increased to about 60 % [74].

PerfluorAd is used as the first PFAS treatment step within a treatment train. Thus, this process is not intended to achieve final target threshold values (e. g. 0.1 $\mu\text{g/L}$) as it is recognised that a further polishing step is required [4]. However, stand-alone applications are also possible, e.g. for the after-treatment of retentate from reverse osmosis systems or for the recirculation of PFAS-contaminated groundwater, which is treated exclusively with the PerfluorAd technology, in order to then discharge this water into the subsurface and thereby remove the hot spot. Depending on the PFAS concentrations present in the groundwater downstream, either an exclusively activated carbon or a combined PerfluorAd-activated carbon-system can then be used to ensure the required discharge values [VENDOR].

Treating a fire-extinguishing water with PerfluorAd showed that, in addition to an almost complete elimination of PFAS, a decolourisation of the water and an elimination of particles [VENDOR 75]. The removal of particles and turbidity are seen as positive as these could decrease the operating time of a subsequent adsorption (i.e. polishing) filtration step.

5.2.1.3. Sensitivity to water matrix components

According to the vendor, no significant interferences with a high DOC, are expected [VENDOR].

Influence of non-fluorinated anionic surfactants has been observed, i.e. in the case of very highly concentrated fire extinguishing water, a high surfactant concentrations can result in an increased PerfluorAd dosage (max 2.0 g/L) [VENDOR].

No studies are available that specifically investigate the influence of pH, electrical conductivity, or the presence of petroleum compounds on the PerfluorAd process.

5.2.1.4. Pre-treatment requirements and residue management

Pre-treatment is required when the subsequent polishing stage is susceptible to a certain co-contaminant, which is not removed during flocculation. Iron containing groundwater does not need to be pre-treated, because iron is precipitated during PerfluorAd application. However, the PerfluorAd process does not remove manganese. To protect the following adsorption filtration process, a pre-treatment for manganese removal might be necessary [VENDOR].

The process creates a PFAS containing sludge that is separated from the water [4]. Since PerfluorAd active ingredient is completely biodegradable, the technology does not lead to a high formation of residues. This is due to the relatively higher PFAS-active substance ratio that can be achieved ($> 1.0\%$), compared with activated carbon (0.01 to max. 0.1 %) [VENDOR].

5.2.1.5. Case studies

Some case studies already exist but they are not named/identified by the technology vendor. Detailed information about case study investigations are provided in Section 7.7.

5.2.1.6. Conclusions and knowledge gaps

The knowledge gaps for PerfluorAd that should be addressed are:

- the achievable removal efficiencies for different PFAS components in groundwater and firefighting water treatment;
- the quantities of residues (e.g. sludge) that are generated using this process and require subsequent treatment should be determined;
- the influence of the pH and salinity on the process should also be verified experimentally.

5.2.2. InSite

5.2.2.1. General description and PFAS removal mechanism

The Australian company InSite Remediation Services offers an ex-situ treatment for PFAS removal from water (InTreat Water) based on a multistage flocculation/sedimentation predominantly automatized approach (patent pending). A final downstream polishing step is required (e.g. adsorption filtration) [VENDOR 76]. For a more detailed process description, see Section 7.8.

Due to proprietary formulations of the flocculant (called InTreat), no detailed evaluation of the removal mechanism can be made, but removal of PFAS occurs either by a coagulation and flocculation process or by electrostatic interactions with the flocculent.

According to the vendor, the chemical dosage and the residence times can be determined by prior bench-scale experiments (e.g. residence time per reactor 60 seconds, chemical dosage 1 g/L). However, these parameters might strongly depend on site-specific conditions. The InSite treatment process is applicable for PFAS concentration ranges from the $\mu\text{g/L}$ up to 120 mg/L range [VENDOR, 77].

Figure 13. PFAS flow diagram for treatment with InSite

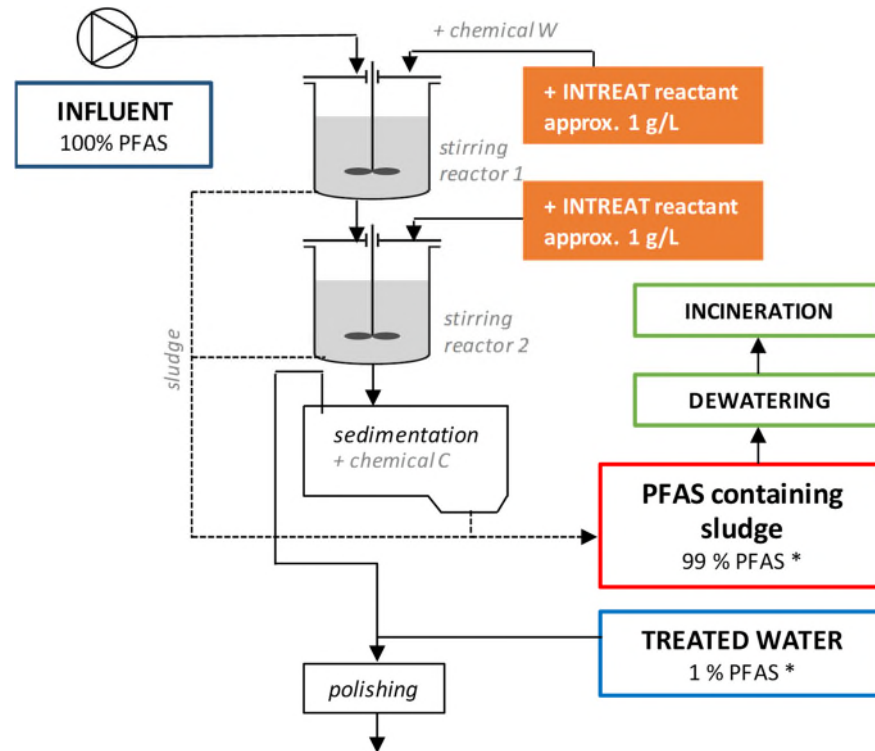

* indicative value based on lab-scale experience; removal efficiency and target PFAS concentrations strongly depend on the PFAS components to be removed and site-specific conditions (e.g. influent concentration, presence of competing substances, etc.) [77]

5.2.2.2. PFAS removal efficiency and costs

The published data about the treatment efficiency of InSite is limited to data provided by the vendor and has therefore not been verified.

Bench-scale experiments (two-stage reactor, without polishing) using 2 g/L InTreat indicated an efficient removal of PFAS up to 99.999% [VENDOR 77].

In pilot-studies, treating water containing PFOS concentrations that are characteristic for a firefighting wastewater resulted in a very high removal efficiency of 99.99% for PFOS [VENDOR 76]. However, whether the final concentration levels cited were measured before or after the final polishing step could not be clarified. Furthermore, the flocculent dosage used in these studies was not given.

Residual concentrations in the treated water indicate that the US-EPA Health Advisory levels for PFOS and PFOA (0.07 µg/L) as well as the proposed EU drinking water threshold of 0.1 µg/L for individual PFAS compounds (0.5 µg/L for total PFAS) are achievable with the InSite technology. Very high influent concentrations however lead to an exceedance of these values [VENDOR 76, VENDOR 77].

As long as the vendors recommendations for incorporating a final polishing step are followed a lower chemical dosage seems economic (i.e. initial InSite treatment significantly reduces PFOS concentration reaching effluent values less than 0.1 µg/L) [VENDOR 76].

5.2.2.3. Sensitivity to water matrix components

Due to the limited information that is available about the additives, no detailed evaluation is feasible to assess whether pH or presence of dissolved organic matter or petroleum compounds negatively affect the removal efficiency. However, it is likely that a high DOC or high TPH content might increase the demand for chemicals.

The pH might govern the occurrence of the different reactive species that result from chemical dosage and thus might have an impact on the efficiency of the process.

Regarding the susceptibility towards a high salt content, experiments demonstrated that a high salinity up to 60,000 $\mu\text{S}/\text{cm}$ caused no significant effect on the removal of PFOS, PFOA and PFHxS [VENDOR, 77].

5.2.2.4. Pre-treatment requirements and residue management

As the InSite technology shows similarities to the PerfluorAd technology, a removal of manganese from groundwater might be required, if manganese is present in groundwater. In addition, a removal of iron cannot be excluded.

As is the case with the PerfluorAd technology the PFAS containing sludge generated as residue of the InSite process requires further processing, e.g. the sludge must be dewatered and the PFAS destroyed via incineration.

5.2.2.5. Case studies

There is one pilot study available where a firefighting wastewater was treated using the Insite treatment technology (see Section 7.8).

5.2.2.6. Knowledge gaps

The knowledge gaps for the InSite technology are:

- the removal efficiencies for different PFAS, especially short-chain PFAS;
- the influence of co-contaminants and the pH should be verified experimentally;
- the amount of residue that is collected during the process which requires further processing/treatment should be determined.

5.3. LIQUID-LIQUID SEPARATION TECHNOLOGIES

Liquid-liquid separation technologies aim to transfer (concentrate) the PFAS into a smaller volume of water. As a result, two phases are obtained. In one phase, the PFAS accumulate, whereas the other phase is (more or less) free of PFAS [3, 4, 8].

Liquid-liquid separation technologies represent only one stage within a treatment train as the PFAS-enriched phase generated requires a final further treatment step to destroy the PFAS it contains. However, this can be seen as useful pre-treatment process that might lead to economic benefits. For example by decreasing the volumes of water, significant energy savings might arise by using liquid-liquid treatment prior to destruction-based approaches. Whether the effluent has to be further treated to reach the treatment goal depends on the individual technology used [3, 4, 8].

5.3.1. Nanofiltration/Reverse Osmosis

5.3.1.1. General description and PFAS removal mechanism

Filtration with dense membranes like nanofiltration (NF) and reverse osmosis (RO) is a non-specific technology that separates nearly all water solutes except for gases. The retardation effect is based on a combination of a physical separation and chemical interactions of solutes with the membrane material. Reverse osmosis membranes are very dense with an average pore size of < 0.5 nm and their retardation efficiency is higher than that of nanofiltration membranes with an average pore size of 0.5 to 2 nm [5, 8].

Due to the small pores of the membranes, a high pressure of about 5 to 10 bars has to be applied to treat drinking water with these technologies [143]. Thus, energy costs are a major part of the operation costs of this technology [4, 8].

In **Figure 14** a PFAS flow diagram is illustrated, including pre-treatment requirements and residue management.

Figure 14. PFAS flow diagram for membrane filtration with NF and RO

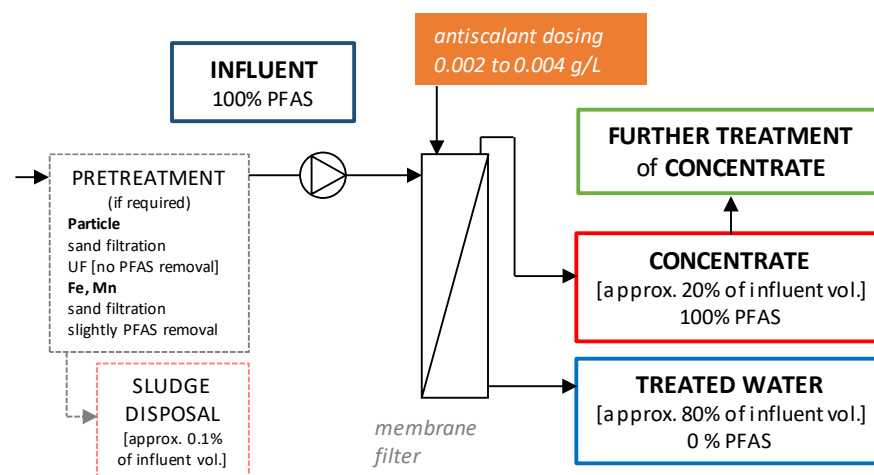

5.3.1.2. PFAS removal efficiency and costs

Removal efficiencies for all PFAS are between $> 90\%$ and $> 99\%$ depending on the membrane type and the individual PFAS [2, 78, 79, 80, 81]. RO membranes retain $> 99\%$ of PFAS, including short-chain PFAS [82] and the treated effluent meets both the US-EPA Health Advisory levels and the proposed EU drinking water thresholds.

The retained solutes (e.g. salts and PFAS) accumulate in a liquid concentrate while the filtered permeate is nearly free of salts and solutes [8, 143]. Under usual operating conditions, the volume of the concentrate is about 20% of the feed volume that enters the membrane device [143].

Energy costs for pumping are calculated by the authors of this report to be in the region of 0.4 kWh/m³. With an energy price of 0.15 €/kWh, energy costs of 0.06 €/m³ would occur. Additional operational costs result due to chemical dosing (e.g. dosage of anti-scalants) and disposal of the retained solutes.

Membrane filtration can be used both for groundwater and fire-fighting water treatment. In the latter case, a more intensive pre-treatment is required as suspended solids would result in rapid membrane fouling.

5.3.1.3. Sensitivity to water matrix components

Inorganic fouling (scaling) due to deposition of dissolved salts that accumulate at the feed side on the membrane surface impede the mass transfer over the membrane and decrease the flux. Consequently, a higher energy input (feed pressure) must be used to maintain the flux or cleaning measures must be applied, both lead to higher operational costs. Scaling is usually prevented by dosage of an antiscalant into the feed [8, 83, 143].

Organic fouling due to deposition of organic water matrix components onto the membrane surface also impedes the mass transfer [83, 143].

The water temperature affects the viscosity of the water and highly affects the flux over the membrane. Hence, lower temperatures have a negative effect on the efficiency of the membrane process and cause higher operational costs [143]. It is however expected that the PFAS removal efficiency however should not be significantly affected. The PFAS removal efficiency however should not be significantly affected.

5.3.1.4. Pre-treatment requirements and residue management

For the treatment of water with dense membranes, it must be free of particles, as well as of iron and manganese (see chapter 5.1.1.4). For the application of NF and RO membranes in drinking water treatment, feed water concentrations of < 0.05 mg/L iron, < 0.02 mg/L manganese, and < 1 FNU turbidity are required [83].

A reduction of turbidity can be realized by filtration via quartz sand (the same step could be used for iron and manganese removal) or via less dense membranes like microfiltration or ultrafiltration membranes. Because no PFAS are retained by micro- or ultrafiltration [3], the rinsing water should not contain any PFAS and their discharge into a river should not be problematic.

The PFAS containing concentrate has to be further treated to destroy PFAS.

5.3.1.5. Case studies

There are no case studies concerning PFAS remediation via NF or RO filtration available. Nevertheless, during drinking water softening with NF or RO, in some cases a PFAS removal is also requested [144]. Further data on treatment efficiencies is provided in Section 7.9.

5.3.1.6. Knowledge gaps

NF/RO is a well established technology commonly used for water treatment. Although it can be argued that there are no specific technology knowledge gaps regarding use there are:

- no case studies concerning PFAS remediation via NF or RO filtration available;
- due to the lack of case studies there is limited information on the actual costs involved to treat PFAS in firefighting and groundwaters.

5.3.2. Foam fractionation and ozofractionation

5.3.2.1. General description and PFAS removal mechanism

Foam fractionation is a technology that makes use of the foam-forming properties of the PFAS. The process selectively separates PFAS from water by injection of

compressed air (foam fractionation) or ozone (ozofractionation) in form of air bubbles into the water. PFAS surfactants adhere to be bubble walls and thereby are transported to the surface and the PFAS-enriched foam is collected at the aqueous surface for further destruction-based treatment. The treated water normally passes through a polishing step [4].

Foam fractionation via compressed air is commercialized by the Australian company OPEC systems, allowing a continuous on-site treatment process in a containerised system. The treatment system is called Surface Active Foam Fractionation (SAFF). The operation mode of the system can be adjusted to manage a broad range of total detectable PFAS influent concentrations (0.1 to 100,000 µg/L). The residence time per reactor vessel ranges from 5 to 30 minutes. PFAS-enriched foam is removed with a vacuum extraction system [VENDOR 84, 85].

Ozofractionation is commercially available by the Australian company EVOGRA. The process is named Ozofractionative Catalyzed Reagent Addition (OCRA). In the OCRA process, the PFAS contaminated water is treated via micro- and nano-sized ozone bubbles (< 200 µm) within an ozofractionation chamber. Besides the ozofractionation vessel, the plant includes a feed tank, an ozone generator and, dependant on treatment requirements, may include a polishing step [4, VENDOR].

The removal mechanism of both techniques benefits from the chemical nature of PFAS and their gas-water partitioning behaviour. The hydrophobic per- and polyfluorinated carbon chains of the PFAS and their hydrophilic functional groups preferentially migrate to the gas-water interface and arrange themselves at the interface according to their chemical preferences. The PFAS-loaded bubbles are then transported to the water surface and removed [4, 6].

SAFF and ozofractionation can both be applied in ex-situ (pump and treat) applications whilst a derivative of SAFF entitled Downhole Foam Fractionation (DFF) can be applied in-situ [VENDOR].

Figure 15 gives the PFAS flow diagram of a two-stage foam fractionation process, also three-stage process are available [VENDOR].

Figure 15. PFAS flow diagram for foam fractionation

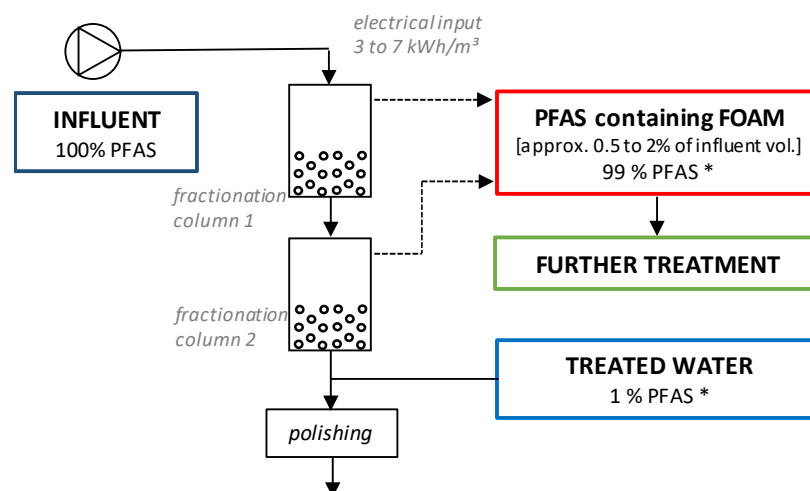

* indicative value based on available data; removal efficiency and target PFAS concentrations strongly depend on PFAS components to be removed and site-specific conditions (e.g. influent concentration, presence of competing substances, etc.).

5.3.2.2. PFAS removal efficiency and costs

In case of foam fractionation, results from laboratory experiments indicated an effective removal of PFAS of up to 99% without polishing. Further, removal of some precursor substances was observed [VENDOR 84]. Further, results from an extended large scale Australian field trial indicated an effective removal of PFAS compounds (PFOA, PFOS, PFHxS, PFNA, FTS) of 100% without polishing. In addition, removal of some precursor and partial removal of short chain PFAS substances was observed [VENDOR].

The ozofractionation showed very high removal rates in field-applications treating surface water contaminated with PFAS. Here, removal rates of about 99.97% could be reached during a multistage fractionation for different long-chain PFAS. Short-chain PFAS and precursor substances were also removed without polishing [VENDOR 128].

The results further indicate that, for PFAS concentration levels below 0.3 µg/L, a high elimination down to a few ng/L could still be achieved [VENDOR 128]. In addition, transformation of precursors into PFAS due to the oxidative character of the ozone was observed [4].

For both foam fractionation and ozofractionation the review of the data indicates that, depending on influent concentrations, the US-EPA Health Advisory levels for PFOS and PFOA (0.07 µg/L) as well as the proposed EU drinking water threshold of 0.1 µg/L for individual PFAS compounds (0.5 µg/L for total PFAS) are achievable without polishing [4, VENDOR 84].

Both technologies usually include a final polishing step, resulting in removal efficiencies of 99.9% to 99.99%. Very high influent concentrations might be managed via a multi-stage fractionation process [4, VENDOR, 128].

The volume of the foam-concentrate from a two-stage ozofractionation process is about 0.5 to 2% of the influent volume [4]. The volume reduction of foam fractionation with air (SAFF) following a three stage (primary, secondary and tertiary) fractionation process is a very efficient 0.0025% of the influent volume [VENDOR].

A rough estimate given by the vendor suggests an energy demand for ozofractionation ranging from 3 to 7 kWh/m³. Costs for the final polishing step have not been provided for ozofractionation. However, the costs would be site-specific and hence could vary significantly [VENDOR].

The foam fractionation system, including the pre-treatment and the final polishing stages, has an energy demand of 2.7 kWh/m³ based on 9 months of continual full scale operation [VENDOR].

5.3.2.3. Sensitivity to water matrix components

Co-contaminants that affect the SAFF process are not specified in the available literature [VENDOR 84]. Extended field trails indicate that the physical separation nature of foam fractionation is not particularly sensitive to co-contaminants such as dissolved hydrocarbons, high turbidity or metals. However, to optimise fractionation and protect against any potential impacts to fine polishing resins, pre-treatment steps are applied (depending on the water matrix) upstream to the fractionation process [VENDOR].

At least for surfactants other than PFAS, it was found that a higher salt content in the water increased the amount of surfactants in the foam during foam fractionation [86].

Regarding ozofractionation, the chemical oxidation of co-contaminants via ozone, e.g. of dissolved organics and petroleum compounds, might lead to a rapid depletion of the ozone and in consequence, increase operation costs [4, 6]. However, the depletion of ozone is not critical for the treatment mechanism, and works for high co-contamination concentration as well as for low [VENDOR]. Furthermore, ozone is an effective oxidant for breaking down co-contaminants such as natural organic matter (NOM) and petroleum hydrocarbons [VENDOR].

5.3.2.4. Pre-treatment requirements and residue management

Pre-treatment will be required to reduce levels of co-contaminants for foam fractionation to allow an economic operation [VENDOR].

For ozofractionation, no pre-treatment other than removal of large bulk solids is required [VENDOR].

Metals such as iron, manganese, copper, lead & zinc precipitate to insoluble metal oxide species and are either removed by physical filtration or are removed with the foam fractions, thus avoiding fouling the polishing step [VENDOR].

5.3.2.5. Case studies

There are a few case studies provided by the vendors for foam fractionation and ozofractionation (see Section 7.10).

5.3.2.6. Knowledge gaps

The knowledge gaps for foam fractionation and ozofractionation include [VENDOR]:

- the influence of co-contaminants on the separation process for foam fractionation;
- evaluation of foam fractionation at field scale field trials at varied sites to assess the influence of different water chemistries and lithologies;
- the potential to optimise energy efficiencies using fractionation;
- determination of the optimal waste stream (PFAS concentration) for effective disposal using either on site 3rd part destruction cells or off-site thermal treatment options.

5.3.3. Adsorptive liquid-liquid separation

Some of the discussed adsorbents such as ion exchange materials or the CustoMem adsorbent can be regenerated to allow a reuse of these materials for further adsorption cycles. During the regeneration procedure, a regenerate is obtained that contains the PFAS that is removed from the water. However, the regenerate volume is usually much smaller than the initial volume of the treated water [4, 8].

Hence, these adsorption technologies can also be classified as liquid-liquid separation technology, generating a residue that requires further treatment to finally destroy the PFAS. Further information about the adsorptive liquid-liquid

separation technologies is provided in the respective Sections: Ion exchange (single use or with regeneration)

5.1.5 CustoMem

5.1.6 Cyclodextrin-based adsorbent

5.3.4. Vacuum distillation

Vacuum distillation as single treatment step is a liquid-liquid separation technology separating the PFAS from the bulk water and providing a reduced volume of aqueous solution that contains the PFAS and requires further destructive treatment [1, 87].

During vacuum distillation, the PFAS are expected to accumulate in the residue due to their low volatility [87]. However, experimental data showed that PFAS were also present in the distillate with the fraction of long-chain alkyl carboxylates in the distillate being higher than the fraction of short-chain alkyl carboxylates [1]. Moreover, volatile precursors such as fluorotelomer alcohols might preferably be present in the distillate. Thus, to further separate the PFAS from the distillate, a multistage distillation might be required [1].

The vacuum distillation process is available by the company Econ Industries (Germany). The so-called VacuDry system is capable to reduce the influent volume of an AFFF solution down to 20%. The residual concentrations in the distillate were less than 0.1 µg/L for PFOS and about 3.5 µg/L for PFOA [VENDOR].

Hence, the distillate might require further treatment to reach the US-EPA Health Advisory levels for PFOS and PFOA of 0.07 µg/L.

See Section 5.4.5 for a treatment system of vacuum distillation combined with plasma destruction.

5.4. DESTRUCTION TECHNOLOGIES

The technologies described in Sections 5.1, 5.2, and 5.3 are capable of removing PFAS from water, but result in a residue (water, sludge or both) loaded with PFAS. To provide a sustainable solution, further treatment of the residues is required that degrade the PFAS into non-hazardous products leading ultimately to the final destruction of the PFAS [4, 5, 8].

Due to economic and ecological reasons, the volume of PFAS containing water should be minimised before the application of destructive technologies. Thus, water or liquid destruction or incineration might be the final treatment step to handle only a small volume with high concentrations of PFAS (i.e. following on from a 'concentration' type technology). However, a destructive technology may be a cost-effective solution when relatively small volumes of water with high concentrations are to be treated (e.g. treating firefighting water) [2, 4, 8, 88, 89, 105].

Destruction technologies result in full degradation of PFAS in water and as a consequence all treatment targets are achieved [4, 8].

5.4.1. Electrochemical degradation

5.4.1.1. General description and PFAS removal mechanism

The degradation of organic compounds by electrochemical technologies is based on an electron transfer process, leading to degradation of the PFAS. The electrons are

generated from an electrical anode that requires a power supply. Electrochemical degradation of PFAS can be achieved effectively with boron-doped diamond electrodes [2, 88, 89]. An effective degradation has also been demonstrated using PbO_2 and SnO_2 electrodes [90].

As electrochemical oxidation is not selective, water ingredients like chloride (Cl^-) or bromide (Br^-) can be oxidised, too. Thus, by-products with an ecotoxicological or human toxicological relevance like chlorate (ClO_3^-), perchlorate (ClO_4^-), or bromate (BrO_3^-) can be formed. Furthermore, by reaction with chloride and organic matter organohalogen compounds might be formed which can analytically be described by the surrogate parameter AOX (adsorbable organic halides) [91]. The occurrence of these by-products is of higher relevance in drinking water treatment than in groundwater or fire-extinguishing water remediation, where the treated water is not consumed by humans but discharged, e.g. to a river.

The application of electrochemical degradation for PFAS is shown in **Figure 16**.

Figure 16. PFAS Flow diagram for electrochemical oxidation of PFAS

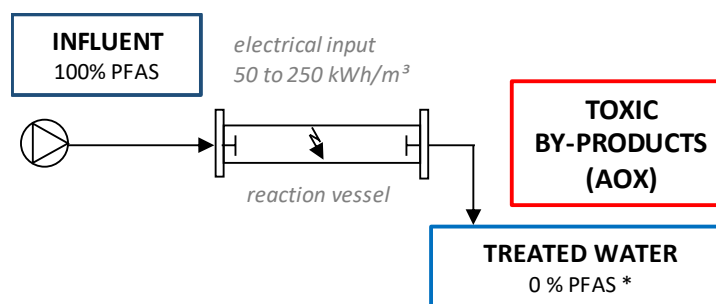

* Mineralization is achievable but strongly depends on operating parameters. Formation of by-products depends on water matrix [2, 88, 89].

5.4.1.2. PFAS removal efficiency and costs

Electrochemical degradation is an effective technology for the complete destruction of PFAS. The total energy consumption is between 50 kWh/m^3 for groundwater treatment with lower PFAS concentrations (e.g. up to $100 \mu\text{g/L}$) [2, 88] and 250 kWh/m^3 for industrial wastewater containing 1.6 mg/L PFAS which is comparable to the content in firefighting water [89].

With an energy price of 0.15 €/kWh , energy costs between 7.5 €/m^3 and 38 €/m^3 result.

Besides PFAS and precursor substances other components in the water matrix such as natural organic matter (DOC), bromide, and chloride are almost completely degraded. As mentioned previously, the formation of toxic by-products can occur and is an important consideration as the water may require additional treatment prior to discharge. Electrochemical degradation is more suitable if the occurrence of these by-products is irrelevant or if the pre-treated water does not contain any precursor substances [2, 4, 88].

5.4.1.3. Sensitivity to water matrix components

Like PFAS, other dissolved organics are degraded during water treatment with electrochemical degradation (traceable by DOC removal) [2, 88]. Hence, petroleum compounds will probably also be degraded during this treatment. However, in

comparison to treatment of water with low DOC it is possible that waters containing a high level of DOC may require longer electrolysis times to achieve the same PFAS removal efficiencies.

It was found that at lower pH values a higher degradation rate for PFOA occurred [90] although one negative effect is that corrosion of the electrode is facilitated at low pH values [4].

The presence of dissolved electrolytes or a high conductivity allows faster electron transport and hence higher degradation rates [90]. In addition, adsorption of sulphate anions onto the active sites of the anode was observed, resulting in reduced degradation of H4PFOS [90].

Higher temperatures are associated with higher mass transfer rates of the PFAS and increasing degradation ratios were observed [90].

5.4.1.4. Pre-treatment requirements and residue management

No further treatment technologies are required, as long as a total mineralization of the PFAS is achieved. However, toxic by-products are potentially formed (depending on the water matrix) and where this occurs can complicate the discharge of the treated water (i.e. may result in unacceptable toxicity of the effluent) [4].

5.4.1.5. Case studies

There are no case studies about groundwater remediation or fire-extinguishing water treatment with electrochemical degradation available. More detailed data about PFAS removal via electrochemical processes is given in Section 7.11.

5.4.1.6. Knowledge gaps

The knowledge gaps for electrochemical degradation include:

- Lack of case studies for groundwater remediation or fire-extinguishing water treatment with electrochemical degradation;
- lack of information of potentially toxic by-products formed. This could be an important consideration if there is a limiting boundary condition for discharging treated water (e.g. to a river);
- linked to the above lack of information regarding ‘acceptable’ levels of chloride, bromide and DOC which can be treated.

5.4.2. Oxidation processes

5.4.2.1. General description and PFAS removal mechanism

The general mechanism of PFAS oxidation is based on a cleavage of the atomic bond between carbon and fluorine atoms (C-F bond). This might be achieved by an ozonisation or via advanced oxidation processes (AOP). The latter can be induced by the combined treatment with ozone and UV radiation, ozone and hydrogen peroxide (H₂O₂), or H₂O₂ and ferrous iron (Fenton’s reagent). All of these approaches produce hydroxyl radicals (OH·) which initiate the chemical oxidation [3, 4, 5]. PFAS treatment with UV radiation as a solely applied (stand-alone) technology is discussed in Section 5.4.4.

Oxidation is capable to transform PFAS precursor substances into PFAS and this treatment is also used for analysis by TOP assay [38].

Additionally, AOP can also be based on the production of sulphate radicals ($\text{SO}_4^{\cdot-}$) that start the initial oxidation process. These radicals can be generated by UV photolysis and reduction of peroxodisulphate ($\text{S}_2\text{O}_8^{2-}$) or peroxomonosulphate (HSO_5^-) [92].

The oxidation technology is realized by dosing the oxidation reagent into the water and, if necessary, applying radiation via an UV device. These process steps are normally carried out continuously. A reactor has to be installed to provide enough time for reaction to occur (see flow diagram in Figure 17) [143].

Figure 17. PFAS flow diagram for oxidation processes

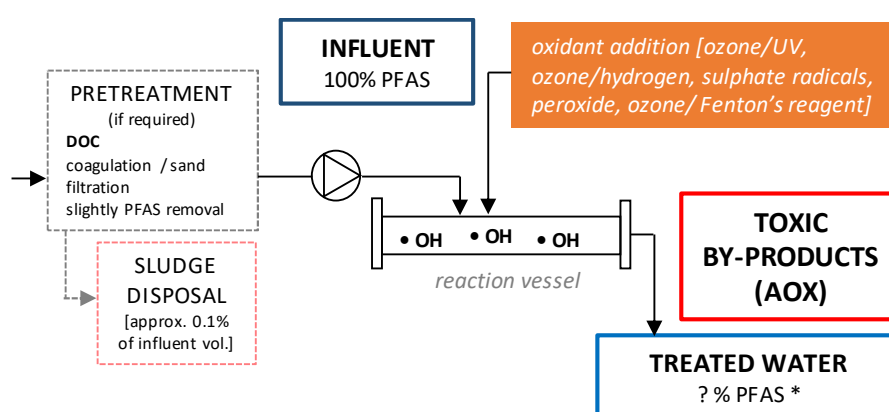

* Formation of by-products depends on water matrix.

5.4.2.2. PFAS removal efficiency and costs

As the chemical bond between carbon and fluorine is very stable, oxidation processes are not very efficient for the degradation of PFAS [3, 5].

Oxidation processes that are based on the production of hydroxyl radicals are not effective for PFAS destruction [3, 93, 129].

In contrast, sulphate radicals based AOP exhibit a stronger degradation of PFAS. Within a relative short reaction time, perfluorinated carboxylic acids like PFOA can be transformed to hydrogen fluoride (HF) and carbon dioxide (CO_2), which means that total mineralisation occurs. Perfluorinated sulfonic acids like PFOS on the other hand are not or only marginally degraded by sulphate radicals [80, 92, 93].

Using chemical oxidation processes, no electrical energy is needed. On the other hand, very high concentrations (hundreds of mg/L up to g/L) of sulphate radicals are needed to achieve a significant destruction of perfluorinated carboxylic acids [92]. For example by adding 2 g/L of peroxodisulphate a destruction of about 50 % of PFOA has been observed within 7 h.

5.4.2.3. Sensitivity to water matrix components

Natural organic matter shows a strong competition for the oxidation radicals. Thus, this technology is practically limited to “pure” solutions containing almost no DOC [80, 92, 93].

PFAS oxidation by sulphate radicals is more effective under acidic conditions with a pH below 3 [94]. However, interferences of chloride have been observed leading to the formation of unwanted chlorate (ClO_3^-) and perchlorate (ClO_4^-). Furthermore,

chloride diminishes the oxidation strength of the sulphate radical based oxidation process [80, 92, 93].

5.4.2.4. Pre-treatment requirements and residue management

Presence of chloride and bromide leads to the formation of unwanted and toxic by-products. Thus, further management of the treated water may be needed [80, 92, 93].

5.4.2.5. Case studies

An *in-situ* field demonstration using a persulfate-based oxidant mixture called OxyZone has been applied near an airport in the USA to treat a wide range of organic contaminants including PFAS [94, 95]. *Ex-situ* case studies for PFAS destruction are not known. Further information about the *in-situ* field demo site has been provided in Section 7.12.

5.4.2.6. Knowledge gaps

Oxidation processes are not an effective technique to treat PFAS contaminated groundwater or extinguishing water from firefighting events. Treatment with sulphate radicals showed potential to degrade at least PFOA. Since both, firefighting waters and contaminated groundwaters contain PFSA and organic matter, oxidation processes are not assumed to present feasible treatment technologies for these matrices. Therefore, further investigations to fill any knowledge gaps are not advised.

5.4.3. Sono-chemistry

5.4.3.1. General description and PFAS removal mechanism

Sono-chemistry is based on a water treatment with ultrasound with frequencies typically between 20 and 1,100 kHz. The ultrasonic irradiation causes cavitation by microbubble collapse producing locally limited temperatures near 5,000 K. Due to their surfactant like properties PFAS accumulate at the bubble-water interfaces and consequently undergo pyrolytic decomposition [4, 96]. Sono-chemical degradation rates increase with carbon-fluorine chain length [132].

Figure 18. PFAS flow diagram for sono-chemistry

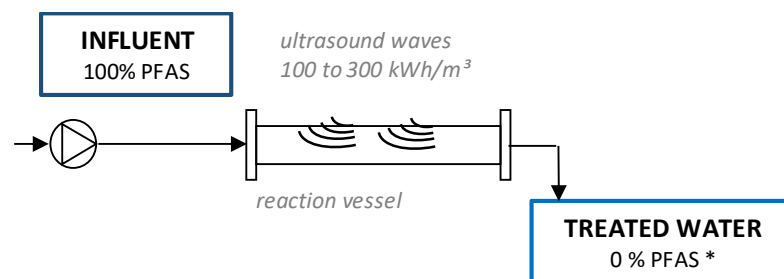

* Mineralization is achievable but strongly depends on operating parameters [96, 97, 98].

5.4.3.2. PFAS removal efficiency and costs

Experimental investigations show a fast degradation and complete mineralisation of PFOS and PFOA when ultrasound with frequencies > 200 kHz is emitted [96, 97].

With increasing concentrations of PFOS and PFOA the degradation kinetics decreases because of an interface saturation with PFAS. However, a noticeable deceleration of the degradation rate has only been noticed at concentrations above 10 mg/L [96].

Energy costs for sonolysis range between 100 and 300 kWh/m³ treated water [4].

5.4.3.3. Sensitivity to water matrix components

Dissolved organic matter in concentrations up to 20 mg/L does not have a relevant negative influence on the elimination rates by sono-chemistry. Furthermore, methanol in a concentration of about 300 g/L exhibits only a small reduction in reaction velocity. Other organic constituents like volatile organic compounds (VOCs) reduce the sono-chemical decomposition rates by a decrease of the bubble vapour and therefore the interfacial temperatures during bubble collapse. Furthermore, organic compounds such as toluene, ethyl benzene, and xylene have shown competitive adsorption onto the bubble water interfaces which has led to a decrease in degradation rate [98]. Therefore, the occurrence of petroleum compounds is likely to have a negative influence on PFAS degradation.

High concentrations of electrolytes have only little or no influence on the sono-chemical degradation rates of PFAS [99].

Low pH values in the acidic range are favourable for sonolytic PFAS destruction [132].

5.4.3.4. Pre-treatment requirements and residue management

Laboratory-scale experiments for groundwater treatment have been performed without any pre-treatment. These indicate that removal of iron and manganese from reduced groundwater is required to protect the sonolysis plant from deposits and pump malfunctions [98].

As sono-chemical treatment results in complete mineralisation of PFAS mineralisation to fluoride and carbon dioxide, no further treatment or disposal of residuals is required [4].

5.4.3.5. Case studies

Further information about lab-scale investigations can be found in Chapter 7.13. However, there are no reported case studies regarding groundwater remediation or fire-extinguishing water treatment with sono-chemistry.

5.4.3.6. Knowledge gaps

Currently, sono-chemical water treatment for PFAS degradation has only been implemented in laboratory and pilot scale. A scale-up to commercial use has yet to be undertaken. Consequently, scale-up challenges might have to be overcome.

5.4.4. UV radiation

5.4.4.1. General description and PFAS removal mechanism

The treatment with UV devices offers the possibility of a continuous water treatment. Through UV radiation, the chemical structure of PFAS can be destroyed due to direct photolysis effects [129, 133].

PFOS only absorbs light with wavelengths smaller than 240 nm. Thus, UV lamps emitting shorter wavelengths (short-wavelength UV and vacuum UV radiation) are more suitable for PFAS photolysis. However, radiation with short wavelengths only has a short penetration depth into the water [80].

For the treatment of waters with low transmittance, special UV reactor designs such as open channel systems with high densities of installed lamps are used. An extreme form of this approach is the application of thin film reactors. A flow diagram for UV radiation, including pre-treatment requirements is shown in **Figure 19**.

Figure 19. PFAS flow diagram for UV-radiation

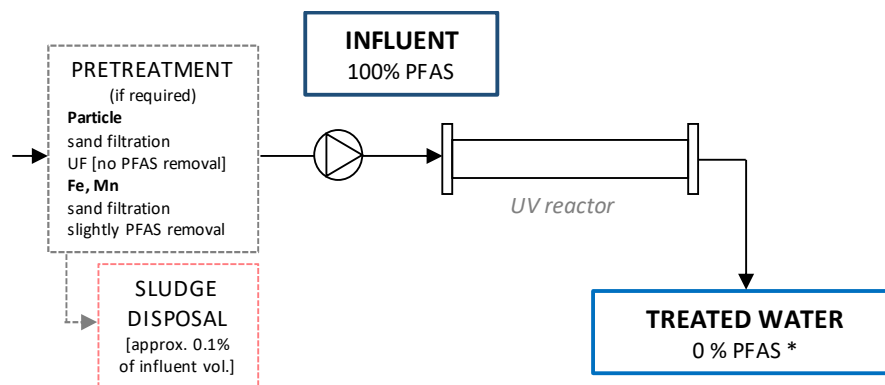

* Mineralization is achievable but required energy input is unknown

5.4.4.2. PFAS removal efficiency and costs

PFAS can be degraded by UV radiation. Short-chain PFAS are formed as intermediate products before a complete degradation occurs [129, 133]. However, UV radiation treatment at commonly applied disinfection doses and at the higher doses used for contaminant removal for drinking water application is reported to be ineffective [3].

The energy demand for direct photolysis to achieve 50% degradation of PFOA is calculated to be in the region of 28 kWh/m³ [80]. This corresponds to about 4 €/m³ assuming energy costs of 0.15 €/kWh. It should be noted that this does not represent the costs for reaching the treatment goals e.g. for PFOA and for a complete degradation of the intermediate short-chain PFAS. Although the amount of energy to achieve these goals is currently unknown.

5.4.4.3. Sensitivity to water matrix components

High amounts of natural organic matter usually decrease the transmittance of the water. This leads to the need for larger UV devices with their associated higher investment and energy costs. Furthermore, natural organic matter absorbs UV radiation and will therefore compete with PFAS. Consequently, it can be expected

that high organic matter (typically measured as DOC) concentrations will lead to a decrease in the degradation rate of PFAS.

Experience from the authors with UV treatment of drinking water has shown that a higher salinity of the water does not negatively influence the process of UV radiation [TZW, Unpublished data].

No information could be as to whether the presence of petroleum compounds will decrease the degradation rate of PFAS. However, as organic compounds they would compete and hence it is expected that they would decrease the degradation rates of PFAS as in the case reported above for natural organic substances.

5.4.4.4. Pre-treatment requirements and residue management

Iron and manganese may build deposits on the UV lamps. Therefore, these compounds have to be removed before any UV radiation treatment. For the application in drinking water treatment, feed water concentrations of < 0.05 mg/L iron and < 0.02 mg/L manganese are required [100].

Furthermore, an increased water turbidity strongly decreases the radiation penetration depth. For drinking water UV devices, a maximum turbidity of 0.3 FNU is required [100]. For chemical degradation, although typically the requirements for turbidity are less rigorous, it is assumed that for PFOS removal to meet protection goals these will be similar to those for drinking water. Consequently, if turbidity greater than 0.3 FNU occurs, a filtration step will be required.

Water with a tendency for calcium carbonate precipitation can also build deposits on the UV lamps. This fact is not relevant for closed UV systems but might be important consideration for the treatment of water volumes with an open surface. This is because carbon dioxide may degas causing an increase of pH and thus an increase of tendency of the calcium carbonate to precipitate [100].

5.4.4.5. Case studies

There are no case studies about groundwater remediation or fire-extinguishing water treatment with UV-radiation reported. However, some experimental investigations regarding PFAS removal with UV-radiation have been done, see Section 7.14

5.4.4.6. Knowledge gaps

Although PFAS degradation by direct photolysis has been proven in lab scale a number of knowledge gaps exist. Based on the literature review these include the following:

- Currently, neither pilot plant or field investigations have been performed on groundwater remediation or fire-extinguishing water treatment with UV-radiation;
- It is unknown, if energy costs can significantly be reduced by adapting the UV reactor design towards a thin film reactor;
- The energy demand to achieve total PFAS mineralization needs to be established.

5.4.5. Vacuum distillation with plasma destruction

5.4.5.1. General description and PFAS removal mechanism

The treatment via vacuum distillation and subsequent plasma destruction is a process which uses a distillation step to concentrate the PFAS into a smaller volume followed by mineralisation of the PFAS in the residual concentrate with a high voltage plasma arc [VENDOR 101, 102].

Econ Industries, a company located in Germany, offers such an automated and on-site continuous treatment process as a mobile treatment unit (size of two shipping containers). The treatment system is called VacuPlas. The main plant components are a vacuum dryer, exhaust gas purification (a flue scrubber working with caustic soda to neutralize the acids that are formed during PFAS mineralization), plasma source, a reaction chamber and a quenching system [VENDOR 101].

The plasma arc is created by passing an electric current through an argon gas stream. The plasma has a very high energy density and is composed of neutral matter, ions and electrons. Core temperatures of the plasma arc are greater than 10,000 °C [102]. The PFAS concentrated water is sprayed/atomized into the plasma arc within the reaction chamber where it is ‘destroyed’ by thermal mineralisation [VENDOR 145].

Figure 20 gives a schematic flow diagram for treatment via vacuum distillation and plasma destruction. The final discharge of the treatment process is an inert brine solution [VENDOR 101].

Figure 20. Flow diagram for the treatment with plasma destruction

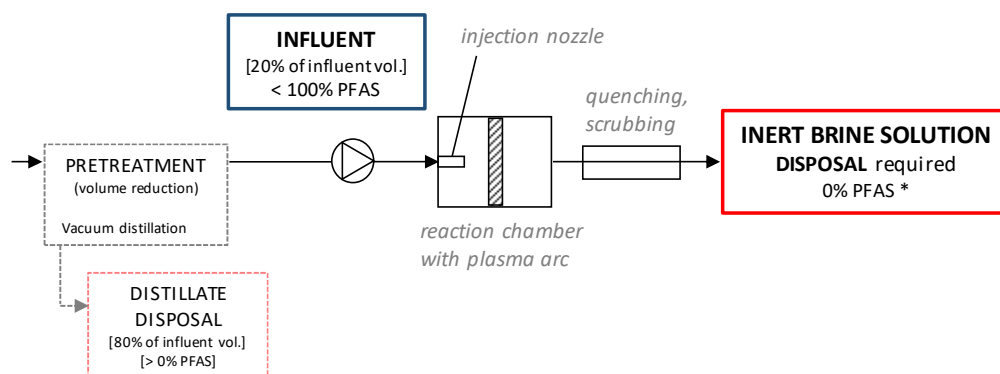

* assumed value, experimental verification is required.

Another application of plasma technology for PFAS removal uncovered in the literature is non-thermal plasma treatment. The degradation mechanism relies on the fact that the electrical discharge of the plasma leads to the formation of reactive species (such as hydroxyl, oxygen and hydrogen radicals, ozone, hydrogen peroxide and free electrons) that sequentially decompose the PFAS [103]. In contrast to other oxidation processes, the radicals are generated due to high voltage induced plasma created without the addition of chemicals [104].

Bench-scale plasma reactors for non-thermal plasma treatment consist of a reaction vessel, a ground electrode and a high voltage electrode. The ground electrode is submerged into the water and the high voltage electrode is placed a few centimetres above the water surface. During the application of the high voltage

plasma is generated and the reactive species are formed. The experimental set-up can be modified by introducing and altering gas bubbling [134].

However, as the PFAS concentrate is sprayed into the plasma arc during the VacuPlas treatment process, the non-thermal plasma destruction may only be of minor significance [VENDOR 145].

5.4.5.2. PFAS removal efficiency and costs

Due to the capability of the thermal technology used to destroy other recalcitrant halogenated organics a total mineralization of the PFAS can be assumed. For example, data from experiments with polychlorinated biphenyls indicate a removal rate of around 99.9999% for thermal plasma treatment [VENDOR].

Vacuum distillation (50 kWh/m³) with plasma treatment is an energy intensive process compared to other destructive technologies such as incineration that result in similar elimination rates. Consequently, the energy-demand might limit the economic efficiency of the process [102, 105]. However, the amount of energy required to destroy PFAS via plasma treatment or incineration is the same, with the difference being that incineration may use the calorific value within other mixed waste streams itself as a fuel source to destroy PFAS making it apparently more economic. But via incineration there may be a risk of PFAS potential formation of derivative by-products and the potential of incomplete thermal degradation of the PFAS molecule itself due inconsistent decomposition during the incineration process, which do not arise within plasma treatment since the system is designed to ensure complete, consistent destruction than blending [VENDOR 145].

To reduce operation costs, the final water volume that requires plasma treatment should be as small as possible. This is why the vacuum distillation is incorporated into the VacuPlas technology. However, where large water volumes need to be treated, a prior concentration treatment step (e.g. reverse osmosis, foam fractionation, or ion exchange with regeneration) of the PFAS contaminated water prior to the VacuPlas process may be required [VENDOR].

During non-thermal plasma treatment, a full mineralization of PFOS can be obtained although formation of PFAS with shorter chain lengths might occur. Based on lab-scale experiments the energy demand required to degrade PFOS with non-thermal plasma treatment was in the region of 12,000 kWh/m³ [135], however, it has also been reported to be 4,500 kWh/m³ [VENDOR]. Assuming costs of 0.15 €/kWh operational costs incurred for energy alone would be ranging from 675 to 1,800 €/m³.

5.4.5.3. Sensitivity to water matrix components

The direct PFAS destruction by the plasma arc is relatively insensitive to changes in the treatable matrix [106]. Co-contaminants, such as petroleum compounds or other organic compounds are mineralized [VENDOR]. This may be useful if these other contaminants need to be removed as part of a site remediation or groundwater clean-up operations.

Although it can be expected that both high salt content and low water temperatures could increase energy demand for the distillation process these will have no impact on its efficiency.

5.4.5.4. Pre-treatment requirements and residue management

During vacuum distillation, iron and manganese might deposit in the vacuum dryer which mean pre-treatment is required.

5.4.5.5. Case studies

There are currently no case studies available reporting PFAS destruction via thermal plasma. non-thermal plasma treatment, see Section 7.15.

5.4.5.6. Knowledge gaps

Although high destruction rates can be assumed during the VacuPlas treatment process, a number of knowledge gaps exist. Based on the literature review these include the following:

- Lack of studies performed on groundwater remediation or fire-extinguishing water treatment with plasma treatment;
- Full mineralization of the PFAS needs to be verified experimentally;
- The fractioning of the different PFAS during the distillation process should be verified in the VacuPlas treatment process;
- The energy demand to achieve total PFAS mineralization needs to be established.

5.4.6. Nanoscale zerovalent iron

5.4.6.1. General description and PFAS removal mechanism

Nanoscale zerovalent iron (nZVI) is a strong reducing agent and is commonly used in *in-situ* applications for groundwater remediation to remove organic pollutants [107]. *Ex-situ* application by adding the iron nanoparticles into the extracted water is also possible. However, this latter kind of application has a very low technical maturity [108, 110].

The nZVI is dosed either as powder or is pre-dispersed in an aqueous solution and is mixed into the water. Applied dosages range from 10 mg/L to 100 mg/L [108]. By coating of zerovalent iron with a stabilizing agent (magnesium-organoclay) it is possible to enhance its dispersion-properties in aqueous solutions to provide a higher reactive surface area. Furthermore, the iron becomes more reactive with decreasing size of the nanoparticles [107].

One major drawback of this technology is that during storage the nZVI material becomes exhausted due to oxidation processes (15% loss of removal capacity in 3 days). To avoid ageing effects, maintaining anoxic storage conditions (e.g. by use of argon gas) is mandatory. This factor might impede transportation, storage and handling of the nZVI material [107].

The removal mechanism of zerovalent iron relies on adsorption of the PFAS on the reactive iron surface and subsequent reductive transformation of the PFAS into smaller and less toxic or non-toxic transformation products. The elemental iron provides the electrons that are required for the reductive decomposition. Transformation products desorb into the solution [108]. Formation of complexes or adsorption of the PFAS is discussed in literature as possible additional removal mechanisms [109].

Figure 21. PFAS flow diagram for treatment with nanoscale zerovalent iron

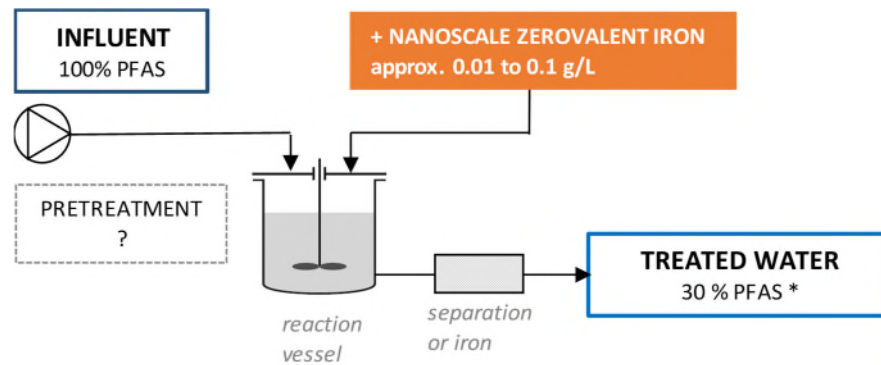

* indicative value based on available data; removal efficiency and target PFAS concentrations strongly depend on the PFAS components to be removed and site-specific conditions (e.g. influent concentration, presence of competing substances, etc.)

5.4.6.2. PFAS removal efficiency and costs

The *ex-situ* treatment of PFAS with zerovalent iron is limited to very few laboratory tests. Due to the low technical maturity as well as weak removal performance of nZVI (at least *ex-situ*) there might be no benefit using this technology currently.

The available experimental data demonstrate removal efficiencies for PFAS in the range of 38% to 94%. However, PFAS removal of water occurred partly due to degradation as well as due to adsorption of the PFAS onto the iron surface. Hence, degradation efficiency for PFAS might be poor [108, 110].

Results indicate that the US-EPA Health Advisory levels for PFOS and PFOA (0.07 µg/L) as well as the proposed EU drinking water threshold of 0.1 µg/L for individual PFAS compounds are not achievable via application of nZVI. Thus, this technology cannot be used as a final removal step and a further polishing step will be required.

In contrast to iron the cost for zerovalent nanoscale iron in bulk form is considerably more expensive. It is commercially available with prices (from 2012 reference) of between 60 to 170 €/kg [107].

5.4.6.3. Sensitivity to water matrix components

No experimental data were found that specifically investigate the impact of dissolved organics or petroleum compounds. However, it can be expected that organic molecules may decompose at the reactive surface of the iron nanoparticles, accelerating the exhaustion process leading to higher material demand.

For magnesium-aminoclay coated nanoscale iron, the influence of the solution pH is substantial. PFAS removal was only observed at pH 3 with no removal seen at higher pH values of pH 5 and pH 7 [108, 110].

Furthermore, at a temperature of 20 °C the PFAS removal rate was higher than at a temperature of 55 °C, for Mg-aminoclay coated zerovalent iron. However, for other contaminants notably 2,4,6-Trinitrotoluene a better removal rate at higher temperatures for uncoated nanoscale iron has been reported [111].

5.4.6.4. Pre-treatment requirements and residue management

There are no reliable data on pre-treatment requirements or residues management of the process available.

5.4.6.5. Case studies

There are a few case studies available for *ex-situ* application of nanoscale zerovalent iron (see Section 7.16).

5.4.6.6. Knowledge gaps

In general, the knowledge gaps are extensive and more research is required to allow an informed in-depth evaluation of this technology. The main critical knowledge gaps are:

- Lack of experimental, pilot scale and field scale data;
- achievable removal efficiencies for different PFAS;
- experimental verification of the impact of co-contaminants.

5.4.7. Water incineration

5.4.7.1. General description and PFAS removal mechanism

The incineration of liquids is performed in rotary kilns. Grate firing with travelling grates or reciprocating grates as utilized for domestic (solid) waste incineration are unsuitable for incineration of liquids [115].

The removal mechanism is based on thermal degradation resulting in a total mineralisation of the PFAS to fluoride and carbon dioxide [23]. Depending on pH, the fluoride will further react and form hydrofluoric acid. In addition, formation of unwanted by-products might occur if the temperatures are not sufficient high to completely mineralize the water constituents [112, 113, 115]. Therefore, to avoid formation of adverse by-products and to degrade the PFAS completely, it is recommended that an incineration temperature of at least 1,000 to 1,200 °C is used [23]. However, Ross et al. reviewed that PFAS are fully destroyed at temperatures between 800 to 1000 °C [4].

Figure 22 depicts the PFAS flow diagram for an incineration process.

Figure 22. PFAS flow diagram for water incineration

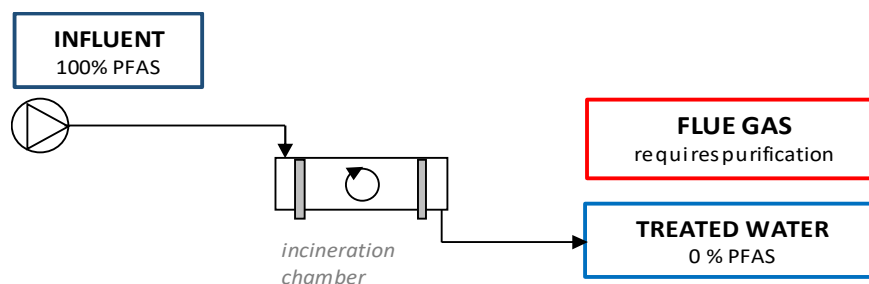

5.4.7.2. PFAS removal efficiency and costs

PFAS in groundwater as well as in fire-fighting water can be destroyed by incineration if the temperature is high enough. The energy costs associated with treating liquid wastes via a special-waste incinerator are in the range of 1,000 to 3,000 €/m³ [114]. Beside this energy demand for the combustion process itself, additional cost arise for flue gas cleaning].

The objective of the flue gas cleaning is to eliminate dust and pollutants such as HX compounds (e.g. hydrofluoric acid), SO_x, NO_x, dioxins, furans and heavy metals that might be present in the combustion gases. The dust can be removed via wet or dry electrostatic measures, a cyclone unit or bag filters. HX compounds can be eliminated via chemisorption, acidic or alkaline washing techniques and NO_x substances by selective non-catalytic/catalytic reduction (SNCR/SCR). Dioxins and furans are removable with a catalyst or activated carbon and heavy metals via wet scrubbing or activated carbon [115].

5.4.7.3. Sensitivity to water matrix components

The incineration process itself is not expected to be sensitive to the water matrix.

5.4.7.4. Pre-treatment requirements and residue management

Due to the high energy costs a pre-treatment concentration technology step (as previously described for other destructive technologies) is recommended to reduce the volumes of contaminated water which is sent for incineration.

In general, no pre-treatment to remove any other water matrix components is expected to be required prior to water incineration.

Besides the flue gas, a small amount of solid residue in form of slag might be generated from the combustion process. If the water has a high suspended load a simple solid separation step (e.g. gravity separator) may be required to reduce the amounts of solid residues produced.

5.4.7.5. Case studies

There are no specific case studies about PFAS destruction with water incineration reported. Nevertheless, various special-waste incinerators like incineration plants of the chemical industry accept liquid waste for disposal using this technology.

5.4.7.6. Knowledge gaps

Although there are no specific case studies the maturity of this technology and its use by licensed waste handlers to treat a range of chemicals in water indicates that there are no significant knowledge gaps to prevent the practical implementation of this technology.

6. COMPARISON OVERVIEW

The technical maturity as well as the reliability of the available data differed widely for the treatment technologies which were evaluated in this report. In the evaluation process performance data derived from full-scale or pilot-scale application with real water matrices is considered more reliable than the results from lab-scale experiments; especially if the latter are performed with demineralized water. Furthermore, performance data obtained from peer-reviewed literature by 3rd party authors is considered to carry more weight and reliability than information provided solely by the technology vendors.

The following two sections provide an overview of the treatment technologies and summarize relevant data which can be used to support the selection of the most suitable process for a specific contaminated site. Evaluation was undertaken based on the respective treatment scenario: groundwater or firefighting water. In **Table 4** and **Table 5** a plus (+) symbols positive aspects, a minus (-) negative ones. A zero (o) stands for a neutral rating. To enhance the evaluation tables, fields are coloured additionally (green positive, yellow slightly positive, orange slightly negative, red negative).

6.1. GROUNDWATER TREATMENT

As a general rule, elimination of PFAS from groundwater is characterized by the treatment of large volumes of water with relatively low concentrations of PFAS. **Table 4** gives a comparative evaluation of the selected technologies for ex-situ groundwater treatment.

In general, **adsorptive techniques** are the most basic method which can be used to eliminate PFAS from groundwater. Treated water is purified by these adsorptive technologies until the adsorptive capacity is reached and breakthrough occurs.

In case of groundwater contaminated with higher PFAS concentrations, the operation of several adsorbent filters in series might be preferred. As a pre-treatment requirement, the removal of iron and manganese (e.g. to drinking water standards) is considered to be mandatory. This is because these constituents can cause excessive fouling of the filter system restricting flow as well as limiting sorbent loading capacities. Furthermore, PFAS may accumulate in the iron and manganese sludge requiring additional management such as back-washing and in some cases require expensive specialist waste disposal.

On the other hand, adsorption technologies are tolerant to a moderate turbidity of the groundwater. Each adsorption technology has its own characteristics and tolerances. For example, high amounts of natural organic matter and presence of petroleum substances adversely affect the adsorption of PFAS onto GAC whereas high salt concentrations, especially high levels of sulphate, inhibit the effective PFAS sorption onto anion exchangers.

For adsorption technologies, the operating time of the adsorbent until the material becomes spent is the key treatment parameter. For the novel adsorbents (other than activated carbon and ion exchange resins) there is currently little or no available data on the operation times when using these for the treatment of real groundwater matrices. Consequently, it is not possible to undertake a rigorous evaluation of performance and the associated costs of these adsorbent based technologies.

When the adsorbent is spent, it must be replaced by fresh and/or regenerated material. The material usage and the disposal costs are the main expenses associated with these technologies. Disposal is usually via incineration or landfill and, as in the case of activated carbon, many vendors will offer to organise the disposal or rejuvenation of the loaded (spent) adsorbent. Other operating costs associated with adsorptive technologies include investment depreciation and pumping costs. These have been estimated to be in the region of 0.2 €/m³ and considered to be of minor relevance compared to the adsorbent material costs [44].

Short-chain PFCA are less efficiently removed by activated carbon compared to long chain PFCA. However, there are more suitable ion exchangers which show a better elimination performance towards this type of PFAS. There are also developing novel adsorption technologies which are claimed to have a better affinity for short-chain PFAS. However, data tends to be from the vendors and hence confidence in results has to be verified.

For many of these adsorbent technology there is no or limited available data on achievable operation times. As it is also not possible to predict the influence of site-specific conditions on these systems it is highly recommended that the selection of the most suitable adsorbent is identified and verified in experimental tests treating the actual PFAS contaminated site water.

For groundwater contaminated with higher concentrations of PFAS, the application of a treatment train should be considered. This could be implemented by a combination of a **flocculation** step to remove significant parts of PFAS followed by a subsequent adsorptive filtration step for further polishing.

The flocculation process could be achieved using the PerfluorAd or the InSite technology. The key parameter for a flocculation process being the amount of flocculent dosage and the respective removal efficiency for the PFAS component(s) targeted for removal. Although for InSite the PFAS removal rates are only known for high flocculent dosage of 2 g/L, much more information is available on PerfluorAd performance where moderate dosages have been demonstrated to be capable to eliminate the bulk of PFAS. Furthermore, full-scale PerfluorAd plants have already been installed and successfully operated removal of PFAS from groundwater.

PerfluorAd technology is proven and amenable to being used in a treatment train. This can be valuable in situations when treatment with a single adsorbent cannot be performed effectively and efficiently (i.e. with acceptable operation times until the adsorbent is exhausted). This technology is especially appropriate if the groundwater contains iron (and no manganese). This is because iron interferes with other adsorbents and has to be removed by an additional pre-treatment step. This pre-treatment can produce PFAS containing sludge which may be expensive to dispose of via specialist waste handlers. As iron is precipitated during the PerfluorAd process, no further pre-treatment or additional costly sludge disposal has to be implemented.

To reduce the volume of water that needs to be treated for PFAS destruction, a **liquid-liquid separation** 'concentration' pre-treatment step could be undertaken. This reduces the volume of water that needs to be treated before performing any high energy destruction-based treatment technology. In fact, a concentration pre-treatment separation step can also be implemented before any other PFAS elimination technology to improve the efficiency (both energy and PFAS removal) of the overall process.

Key parameters to compare different liquid-liquid separation technologies are the energy demand and the corresponding separation factor. The separation factor determines the amount of PFAS containing water which remains after the separation process.

Among the liquid-liquid separation technologies, most practical experience for PFAS removal exists for nanofiltration and reverse osmosis. Both possess a well-engineered technical maturity and during treatment all types of PFAS are removed. Disadvantages of the membrane technologies are the need for an intensive pre-treatment to remove particles and the relatively low degree of concentration of about 80% (i.e. 20% of the raw water remain as PFAS containing concentrate) and a saline matrix of the concentrate due to the high retention of nearly all other components of the water matrix.

Liquid-liquid separations using ion exchange, CustoMem or cyclodextrin-based adsorbents include a regeneration of these materials. Compared to a membrane process, higher separation factors can be achieved resulting in much lower waste water volumes that require further treatment. This in turn leads to lower treatment costs for the subsequent destruction technology. During the regeneration procedure, a regenerate solution (this could be organic solvent, acidic or alkaline solutions) is obtained that contains the PFAS that is removed from the water. This regenerate solution should be more or less suitable for further treatment. However, for these newer adsorbent technologies it is recognised that more research is needed before a full technical implementation can be undertaken.

Foam fractionation is evaluated to be a suitable separation process. The separation factor is less than 2% and thus is much smaller than for membrane filtration or vacuum distillation. The water matrix after treatment is identical to the raw water, which is beneficial for destruction treatment.

The high energy demand required for distillation separation processes limit its applicability to highly PFAS contaminated waters or in areas where there are no other alternative treatment options available. The technology is still only at a pilot phase and its energy consumption may be reduced with further developments. However, as water ingredients like salts as well as PFAS remain in the distillation bottom, this can potentially create problems with the post treatment of the remaining residue water.

Subsequent to a pre-concentration of PFAS and a reduction of water volume, PFAS can be destroyed in off-site water incineration plants (on-site incineration may be possible). As previously mentioned, this approach is a very energy intensive and hence expensive disposal route. As such, preferably only small volumes of water with high concentration of PFAS should be treated using this technology.

Destruction technologies lead to a complete mineralisation of PFAS to fluorine, plus CO₂ and H₂O. Using on-site technologies, no transportation of residuals and no further treatment is required. Thus, in general, providing they are cost effective, destruction technologies are preferred. The key parameter for destruction technologies is their energy demand.

Currently, technologies involving oxidation, UV radiation and nanoscale zerovalent iron are still in development phase and not yet been fully commercialized. High temperature incineration of liquid waste is the only available full-scale technology that mineralizes the PFAS. Amongst the suitable on-site destruction technologies that are considered (electrochemical degradation, sonochemistry and plasma

destruction), plasma destruction appears to be a very energy-consuming procedure (based on experience in lab-scale experiments).

The lowest volume specific treatment costs might be achieved using electrochemical degradation. The formation of toxic by-products needs to be considered if the water contains small concentrations of chloride, bromide and natural organic matter. This needs to be considered because these chemicals may be present in the water as a consequence of different pre-concentration steps e.g. ion exchange with regeneration.

Sonochemical degradation is a potentially promising technology because it makes use of the surfactant like properties of the PFAS. However, as no scale-up to commercial use has been occurred further research is required to obtain both more experience and confidence in this technology.

Table 4. Evaluation matrix for treatment of groundwater

	Technical maturity	Reliability of data	Technical complexity	Reaching threshold values for long-chain PFAS	No need for pre-treatment for Fe / Mn	No need for pre-treatment for turbidity	Impact of high organic matter content	Tolerance of high salt content	Impact of high Petroleum substances content	Mass removal effectiveness for Short-chain PFAS	Mass removal effectiveness for Long-chain PFAS	No use of chemicals	No by-products	Key treatment parameter	Treatment costs
+ positive - negative o neutral															
Adsorption technologies:														Operating time (PFOS)	
Activated carbon	<i>Full-scale</i>	Many peer reviewed data	+	+	-	+	-	+	-	-	+	+	+	40,000 BV	+
MatCare	<i>Pilot-scale</i>	Single peer reviewed data	+	+	-	+	-	+	-	No data	+	+	+	No data	No data
RemBind	<i>Pilot-scale</i>	Single peer reviewed data	+	+	-	+	-	+	-	No data	+	+	+	No data	No data
IEX without regeneration	<i>Full-scale</i>	Many peer reviewed data	+	+	-	+	-	-	-	+	+	+	+	150,000 BV	+
CustoMem without regeneration	<i>Lab-scale</i>	<i>Vendor-Information</i>	+	No data	-	+	-	+	-	No data	+	+	+	No data	No data
Cyclodextrin-based adsorbent	<i>Pilot-scale</i>	<i>Vendor-Information</i>	+	+	-	+	-	+	-	+	+	+	+	6,300 - >55,000 BV	No data
Flocculation technologies:														Flocculent dosage / removal efficiency	
PerfluorAd	<i>Full-scale</i>	Single peer reviewed data	o	+ / -	+ / -	+	-	+	-	+	+	-	+	100 mg/L / 90%	No data
InSite	<i>Pilot-scale</i>	<i>Vendor-Information</i>	o	-	+ / -	+	-	+	-	No data	+	-	+	2 g/L / 99%	No data

	Technical maturity	Reliability of data	Technical complexity	Reaching threshold values	No Fe / Mn pre-treatment	No pre-treatment for turbidity	High organic matter	High salt content	Petroleum substances	Short-chain PFAS	Long-chain PFAS	No use of chemicals	No by-products	Key treatment parameter	Treatment costs
+ positive - negative o neutral															
Liquid-liquid separation technologies:														Energy demand / separation factor	
Nanofiltration, reverse osmosis	Full-scale	Many peer reviewed data	-	+	-	-	+	+	+	+	+	-	+	0.4 kWh/m ³ / 20%	o
Foam fractionation	Pilot-scale	Vendor-Information	-	+	-	+	+	+	+	+	+	+	+ / -	3 - 7 kWh/m ³ / < 2%	o
IEX with regeneration	Pilot-scale	Single peer reviewed	o	+	-	+	-	-	-	+	+	-	+	0.01 kWh/m ³ / 0.01 - 0.1 %	+
CustoMem with regeneration	Lab-scale	Vendor-Information	o	No data	-	+	-	+	-	No data	+	-	+	0.01 kWh/m ³ / 0.01 %	+
Cyclodextrin-based adsorbent	Pilot-scale	Vendor-Information	o	+	-	+	-	+	-	+	+	-	+	0.01 kWh/m ³ / No data	No data
Distillation	Pilot-scale	Vendor-Information	-	No data	-	+	+	+	+	+	+	+	+	50 kWh/m ³ 20%	-
Destruction technologies:														Energy demand for PFAS destruction	
Electrochemical degradation	Lab-scale	Single peer reviewed	+	+	-	+	o	+	+	+	+	+	-	50 kWh/m ³	+
Oxidation	Lab-scale	Single peer reviewed	+	-	-	+	-	+	-	+	+	-	-	No data	No data
Sonochemistry	Lab-scale	Single peer reviewed	+	+	-	+	+	+	-	+	+	+	+	100 kWh/m ³	o
UV radiation	Lab-scale	Single peer reviewed	+	-	-	-	-	+	No data	+	+	+	+	No data	No data
Distillation & Plasma	Pilot-scale	Vendor-Information	-	+	-	+	+	+	+	+	+	+	No data	4,500 kWh/m ³	-
Nanoscale zerovalent iron	Lab-scale	Single peer reviewed	-	-	-	+	No data	No data	No data	No data	+	+	+	No data	No data
Water Incineration	Full-scale	Single peer reviewed	-	+	+	+	+	+	+	+	+	+	+	2,000 €/m ³	-

6.2. FIREFIGHTING WATER TREATMENT

For firefighting water, only a limited amount of water of some hundreds or thousands of cubic metres has to be treated. Treatment plants are typically installed temporarily, for a few days or weeks. Possible treatment technologies for this type of water, which usually contain high concentrations of PFAS including relatively high amounts of precursors and organic compounds, are compared in the following section. An evaluation overview is provided in **Table 5**; the presentation of the assessment is the same as that used for groundwater treatment in chapter 6.1.

For the application of adsorption media, the maximum operating time might be of minor interest but the effectiveness is relevant in terms of final effluent concentrations that can be achieved. Nevertheless, the operation time until threshold values are exceeded determine the volume of adsorption material that is required to achieve the desired level of treatment. Furthermore, operation times will also ultimately affect the treatment costs.

To achieve the ultimate PFAS treatment goals, a multi-stage adsorption treatment may be beneficial. By applying different adsorption media, more adsorption mechanisms can be used resulting in lower effluent concentrations. This approach can be achieved by using an adsorption mixture such as RemBind or by using subsequent treatment steps with two different adsorption media.

The available pieces of information for each of the adsorption technologies does not currently provide verified data on achievable operation times or loading capacities until threshold values are exceeded.

In general, ion exchange resins appear less favourable option due to the high concentrations of organic compounds that will be present in the firefighting water.

Owing to the lack of credible information, it is strongly recommended that adsorption trials are undertaken using real firefighting water (i.e. to account for presence of other contaminants in the water matrix matrices) to determine the most suitable adsorption material.

Additional pre-treatment by **flocculation** technologies like PerfluorAd or InSite might be beneficial if PFAS break through the filter bed early and high volumes of adsorption media would be required. However, when the volume of firefighting water is rather small, an additional flocculation process should not be required to reach the treatment goals provided an adequate amount of adsorption media is used.

For a **liquid-liquid separation**, nanofiltration and reverse osmosis technologies are suitable including an intensive pre-treatment for particle removal. However, no information is available in literature about separation factors in firefighting water treatment. The same knowledge gap applies for ion exchange, CustoMem, and cyclodextrin-based adsorbents including a regeneration step. Due to the higher PFAS concentrations and other contaminants in firefighting water it can be assumed that the achievable separation factors are smaller compared to groundwater treatment and that a more frequent regeneration is needed.

From the available information, foam fractionation seems to be a suitable separation process. According to performance data from the vendor, no further treatment might be needed to reach required threshold values in the range of 0.1 µg/L for PFOS. However, this has yet to be independently verified.

Destruction technologies are evaluated similarly to the treatment of groundwater. In general, one advantage of destruction technologies is the possibility of on-site treatment with no further water transportation. On the other hand, volume specific energy costs for treatment are high. Thus, a pre-treatment for volume reduction would appear to be beneficial.

Sonochemistry and electrochemical degradation are evaluated as most efficient PFAS destruction technologies because their energy demand is much smaller than using plasma treatment or water incineration. Nevertheless, electrochemical degradation may lead to unwanted by-products (depending on the water matrix) and both technologies need further development and validation before technical implementation.

Table 5. Evaluation matrix for treatment of firefighting wastewater (+: positive, -: negative, o: neutral)

	Technical maturity	Reliability of data	Technical complexity	Reaching threshold values	No pre-treatment for turbidity	Petroleum substances	Short-chain PFAS	Long-chain PFAS	No by-products	Key treatment parameter	Treatment costs
			+ positive		- negative		o neutral				
Adsorption technologies:										Throughput	
Activated carbon	Full-scale	Single peer reviewed data	+	+	+	-	-	+	+	No data	No data
MatCare	Lab-scale	Single peer reviewed data	+	No data	+	-	No data	+	+	No data	No data
RemBind	Pilot-scale	Single peer reviewed data	+	+	+	-	+	+	+	No data	No data
IEX without regeneration	No data	No data	+	No data	+	-	o	-	+	No data	No data
CustoMem without regeneration	No data	No data	+	No data	+	-	No data	+	+	No data	No data
Cyclodextrin-based adsorbent	Pilot-scale	Vendor-Information	+	+	+	-	+	+	+	No data	No data
Flocculation technologies:										Flocculent dosage / removal efficiency	
PerfluorAd	Pilot-scale	Vendor-Information	o	+ / -	+	-	+	+	+	No data	No data
InSite	Pilot-scale	Vendor-Information	o	-	+	-	No data	+	+	2 g/L / 99%	No data

	Technical maturity	Reliability of data	Technical complexity	Reaching threshold values	No pre-treatment for turbidity	Petroleum substances	Short-chain PFAS	Long-chain PFAS	No by-products	Key treatment parameter	Treatment costs
			+ positive			- negative			o neutral		
Liquid-liquid separation technologies										Energy demand / separation factor	
Nanofiltration, reverse osmosis	<i>Pilot-scale</i>	Single peer reviewed data	-	No data	-	+	+	+	+	No data	No data
Foam fractionation	<i>Pilot-scale</i>	Vendor-Information	-	+	+	+	+	+	+ / -	3 - 7 kWh/m ³ / < 2%	o
IEX with regeneration	No data	No data	o	No data	+	-	o	-	+	0.01 kWh/m ³ / No data	No data
CustoMem with regeneration	No data	No data	o	No data	+	-	No data	+	+	0.01 kWh/m ³ / No data	No data
Cyclodextrin-based adsorbent	<i>Lab-scale</i>	Single peer reviewed data	o	+	+	-	+	+	+	0.01 kWh/m ³ / No data	No data
Distillation	<i>Pilot-scale</i>	Vendor-Information	-	No data	+	+	+	+	+	50 kWh/m ³ / 20%	-
Destruction technologies:										Energy demand for PFAS destruction	
Electrochemical degradation	<i>Lab-scale</i>	Single peer reviewed data	+	+	+	+	+	+	-	250 kWh/m ³	+
Oxidation	<i>Lab-scale</i>	Single peer reviewed data	+	-	+	-	+	+	-	No data	No data
Sonochemistry	<i>Lab-scale</i>	Single peer reviewed data	+	+	+	-	+	+	+	300 kWh/m ³	+
UV radiation	<i>Lab-scale</i>	Single peer reviewed data	+	-	-	No data	+	+	+	No data	No data
Distillation & Plasma treatment	<i>Pilot-scale</i>	Vendor-Information	-	+	+	+	+	+	No data	4,500 kWh/m ³	-
Nanoscale zerovalent iron	<i>Lab-scale</i>	Single peer reviewed data	-	-	+	No data	No data	+	+	No data	No data
Water Incineration	<i>Full-scale</i>	Single peer reviewed data	-	+	+	+	+	+	+	2,000 €/m ³	-

7. CASE STUDIES OVERVIEW

7.1. ACTIVATED CARBON

Adsorption of PFAS onto granular activated carbon (GAC) is a field-proven technology. Numerous case studies are available. However, given the impact of water matrix and co-contaminants on activated carbon's performance, existing data cannot necessarily be readily extrapolated to design a new system as illustrated by the case studies below.

Using activated carbon (AC), effluent concentrations below the analytical detection limit of about 5 to 10 ng/L can be achieved [3].

Removal efficiencies depend strongly on the type of AC and the identity of PFAS present in a given wastewater. The removal rates may vary within a range of +/- 50% [44, 116]. Equilibrium parameters, especially those determined with deionized water, may not be suitable for breakthrough predictions as shown below.

Equilibrium data for estimating the loading capacity, q (e.g. in $\mu\text{g/g}$), of various PFAS onto a sorbent, based on influent concentrations, have been determined in many investigations. For example, the two constants q_{max} and K_L from Langmuir equation (see Equation 3) are summarized in Table 6 for PFOS [54, 117, 118].

$$q = q_{\text{max}} K_L c / (1 + K_L c) \quad (3)$$

where q_{max} = maximum loading capacity
 K_L = Langmuir constant
 c = equilibrium concentration

With these equilibrium parameters, the (stoichiometric) breakthrough can be calculated assuming an initial concentration of individual PFAS in water. Specifically, calculated breakthroughs varied between 2,000 and 60 million BV using an influent PFOS concentration of 1 $\mu\text{g/L}$. However, the computed value of 60 million BV has never been observed in practical investigations, even if the experimentally determined loadings are real ones and no extrapolated values. Thus, equilibrium parameters, especially those determined with deionized water, are not suitable for breakthrough predictions. Therefore, selecting an appropriate AC for optimum PFAS removal should include experimental investigations determining the throughput until breakthrough using the specific wastewater.

Table 6. Equilibrium data for PFOS and calculated loading, q , and stoichiometric breakthrough expressed as number of bed volumes, BV.

q_{max} ($\mu\text{g/g}$)	K_L (L/ng)	q ($c_0=1 \mu\text{g/L}$) ($\mu\text{g/g}$)	Breakthrough (BV)	Water matrix	Ref.
5.3	0.08	5.2	2,000	Groundwater	[118]
161,300	0.017	152,339	60,000,000	Deionized water	[117]
236,000	$1.24 \cdot 10^{-7}$	29	12,000	Deionized water	[54]

For the performance for removal of other PFAS than PFOS, many laboratory-, pilot- and full-scale investigations have verified that per- and polyfluoroalkyl sulfonic acids (PFSA) are better adsorbed onto activated carbon than per- and polyfluoroalkyl carboxylic acids (PFCA). Likewise, long-chain PFAS are better adsorbed than short-chain PFAS [3, 47, 56, 71, 117, 118, 119]. This difference in affinity can lead to a short-chain PFAS desorption from AC [47, 56].

Therefore, when designing an activated carbon treatment system for PFAS, the adsorption ability for a specific AC in relation to each relevant PFAS in the wastewater to be treated should be determined. If needed, a second activated carbon filter can be installed in series to reach lower effluent concentrations [47].

Case Study #1 - Groundwater Treatment: References [1, 120]

An investigation treating groundwater contaminated by PFAS showed a very efficient removal of long-chain perfluorinated alkyl sulfonates (e.g. PFOS). The treated water volume was reported to be about 40,000 bed volumes (BV) in the pilot plant system. Similarly, for short-chain alkyl sulfonates, about 16,000 BV were treated while 20,000 BV for long-chain alkyl carboxylates could be treated. The breakthrough of short-chain alkyl carboxylates occurred much earlier between 4,000 and 12,000 BV, depended on the exact chain length of the PFAS. Specifically, shorter chain lengths resulted in earlier breakthrough. In addition, earlier breakthrough was also observed with increasing filter velocities and decreasing Empty Bed Contact Times (EBCT), respectively.

<u>Influent Water Composition:</u> PFOS = 0.6 µg/L PFHxS = 0.4 µg/L PFCA < 0.1 µg/L		DOC < 1 mg/L	<u>System Design:</u> 1240 EN GAC (Norit) Filter Volume, V _F = 12 L <i>Pilot-scale</i>
<u>Breakthrough:</u> PFOS: 40,000 BV PFHxS: 20,000BV PFCA: 4,000 - 12,000 BV			<u>Operational Conditions:</u> v _F = 6 or 10 m/h EBCT = 15 or 9 min Flux = 4 or 7 BV/h

Case Study #2 - Groundwater Treatment: Reference [121]

Other pilot scale investigations showed better adsorption performance for perfluorinated alkyl carboxylates using a coconut shell based activated carbon. In this case, 8,000 to 24,000 BV were treated until breakthrough occurred. PFOA, as representative of a long-chain alkyl carboxylate, was treated up to 35,000 BV until the activated carbon was exhausted.

<u>Influent Water Composition:</u> PFHxA = 0.6 µg/L PFPA = 0.6 µg/L PFOA, PFHpA, PFBA = 0.1 to 0.5 µg/L		EC = 600 µS/cm Sulphate = 37 mg/L DOC = 0.7 mg/L	<u>System Design:</u> Hydraffin CC 8x30 GAC (Donau Carbon) Filter Volume: V _F = 140 L (L _F = 2m) <i>Pilot-scale</i>
<u>Breakthrough:</u> PFOA: 35,000 BV PFHxA: 24,000 BV PFPeA: 20,000 BV PFBA: 8,000 BV			<u>Operational Conditions:</u> v _F = 8 m/h EBCT = 15 min Flux = 5 BV/h

Case Study #3 - Firefighting Water Treatment: Reference [46]

A fire-extinguishing water containing PFAS from a former AFFF formulation was treated with activated carbon in a pilot system utilizing two filters in series. Removal efficiencies greater than 99.9% for each of the PFAS was achieved after operating the system for 40 BV. While all short-chain polyfluoroalkyl carboxylic acids were removed to concentrations below 10 ng/L, PFOS remained above the desired treatment goals because of a very high initial concentration. Furthermore, the effluent PFOS concentration after the second reactor remained at similar levels as after the first reactor. This was likely due to the high levels of TOC and COD present in the water causing reduced loading by competitive sorption. Thus, it cannot be predicted if a third reactor in series might have reduced the PFOS concentration further.

<u>Influent Water Composition:</u> PFOS = 9,000 µg/L PFOA = 80 µg/L TOC = 80 mg/L PFHxS = 1,000 µg/L PFHxA = 70 µg/L COD = 270 mg/L PFHpS = 200 µg/L PFHpA = 20 µg/L Turbidity = 1.5 NTU PFBS = 20 µg/L PFBA = 20 µg/L PFPeA = 20 µg/L			<u>System Design:</u> Filtrasorb 600 Filter Volume, $V_F = 400$ L <i>Pilot-scale</i>
<u>Effluent concentration:</u> PFOS = 1 µg/L PFOA = 0.002 µg/L PFHxS < 0.01 µg/L PFHxA = 0.01 µg/L PFHpS < 0.01 µg/L PFHpA = 0.005 µg/L PFBS < 0.0004 µg/L PFBA = 0.005 µg/L PFPeA = 0.005 µg/L			<u>Operational Conditions:</u> EBCT = 20 min Flux = 3 BV/h

7.2. MATCARE

As in the case of activated carbon, equilibrium parameters are used to predict breakthrough for PFOS (see **Table 7**). Equilibrium data for Freundlich isotherms (see equation (4)) have been derived from adsorption experiments using 10 g/L MatCare with initial concentrations from 0 to 200 mg/L PFOS in deionized water for 24 h (without competing components). Further, results indicate relatively fast adsorption kinetics for MatCare, reaching adsorption equilibrium for PFOS within 60 minutes [49].

$$q = K_F c^n \quad (4)$$

where q = equilibrium loading
 c = equilibrium concentration
 K_F = Freundlich constant
 n = Freundlich exponent

Table 7 Equilibrium data for PFOS and calculated loading, q , and stoichiometric breakthrough expressed as number of bed volumes, BV.

n	K_F ($\text{mg}^{1-n} \text{L}^n/\text{g}$)	q ($c_0=1$ µg/L) (mg/g)	Breakthrough (BV)	Water matrix	Ref.
0.235	0.05	0.01	6,000	Deionized water	[49]

Case Study #1 - Fire-Fighting Water Treatment: Reference [VENDOR 50]

In a laboratory-based study with MatCare, a wastewater contaminated with PFAS was filtered through four columns in series and the removal efficiency for long-chain PFAS was determined. The table below gives initial concentrations of the PFAS before and after treatment as well as values for the removal efficiency. By the treatment with MatCare an elimination of the compounds to below the compound specific limits of detection was achieved (removal efficiency 90% to 99.9%).

Nevertheless, only 40 BV of water have been treated, which is a very low throughput. The amount of treated water until breakthrough occurs has not been determined.

<u>Influent Water Composition:</u>		<u>System Design:</u>
PFOS = 75.8 µg/L	PFOA = 2.8 µg/L	MatCare
H4PFOS = 508 µg/L	PFSOA < 0.2 µg/L	4 filters in series
8:2 FTSA = 15.2 µg/L		Lab-scale
<u>Effluent concentration:</u>		<u>Operational Conditions:</u>
PFOS < 0.02 µg/L	PFOA < 0.02 µg/L	-
H4PFOS < 0.1 µg/L	PFSOA < 0.02 µg/L	
8:2 FTSA < 0.1 µg/L		

Case Study #2 - Fire-Fighting Water Treatment: Reference [VENDOR 122]

In a pilot-scale study, MatCare was used to treat fire-fighting wastewater with initial concentrations of 6.85 mg/L PFOA and 35.05 mg/L PFOS to concentrations below quantitation limits.

Similarly, in lab-scale experiments using a fixed-bed filter column the removal efficiencies for PFOA and PFOS (2.77 mg/L and 9.01 mg/L initial concentrations, respectively) were about 99% for an operation time of at least 680 BV. Both substances were removed to concentrations below the limits of quantification.

Unfortunately, in both trials, the quantitation limits were not reported. Whether breakthrough occurred, or the system was capable of operating without breakthrough beyond 680 BV, was also not clear from the description in literature.

<u>Influent Water Composition:</u>		<u>System Design:</u>
PFOS = 35,500 µg/L		MatCare
PFOA = 6,859 µg/L		Pilot-scale
		Lab-scale
<u>Breakthrough:</u>		<u>Operational Conditions:</u>
PFOS: 680 BV		-
PFOA: 680 BV		

Case Study #3 - Fire-Fighting Water Treatment: Reference [VENDOR 50]

In 2011 and 2012, a large-scale treatment plant was implemented at an Australian Air Force base to treat firefighting wastewater contaminated with PFAS. The plant was arranged in a shipping container and included a pre-filtration step, followed by three MatCare filter columns (in parallel mode) and a purification contact chamber. The initial concentrations ranged from about 6 to 14 mg/L for PFOS and from 1 to 2 mg/L for PFOA. The effluent of the pilot plant showed a removal efficiency of 99.9% for PFOS and of 99.7% for PFOA. Both substances were reduced to a

concentration level below 2 µg/L. No data on the filter velocity or operation times until the adsorbent was replaced was included.

<u>Influent Water Composition:</u> PFOS = 6,000 - 14,000 µg/L PFOA = 1,000 - 2,000 µg/L	<u>System Design:</u> MatCare Large-scale
<u>Effluent concentration:</u> PFOS < 2 µg/L PFOA < 2 µg/L	<u>Operational Conditions:</u> -

7.3. REMBIND

In several laboratory and pilot studies, illustrated below RemBind has shown to remove long-chain as well as short-chain PFAS effectively, at least in case of firefighting wastewater treatment.

Adsorption experiments conducted by the vendor give a loading capacity of about 200 µg/g for PFOS and of 4 µg/g for PFOA (considering initial concentrations of about 1 µg/L) [VENDOR 53]. Using equation (2) from Section 5.1 and assuming a filter density of about 1.5 g/cm³ (due to a mixed filter bed with silica sand 50:50 [46]), these loadings correspond to operation times of 300,000 BV for PFOS and 6,000 BV for PFOA.

Case Study #1 - Groundwater Treatment: Reference [VENDOR 52]

In pilot-scale batch reactor tests, a contaminated groundwater was treated with RemBind, containing PFAS in the concentration range from 0.016 µg/L to 4.7 µg/L. Removal efficiencies ranged from 90% to 95% for PFOA and PFOS, respectively. Short-chain PFAS, like PFBS and PFHxA, were eliminated to 100% and 99%, and the precursor substance H4PFOS was diminished to about 97%.

<u>Influent Water Composition:</u> PFOS = 2.9 to 3.4 µg/L PFOA = 0.58 to 1.3 µg/L PFBS = 0.016 to 0.022 µg/L PFHxA = 0.36 to 1.2 µg/L H4PFOS = 0.84 to 1.3 µg/L TOC 1.9 mg/L	<u>System Design:</u> RemBind Plus Batch system Pilot-scale
<u>Effluent concentration:</u> PFOS = 0.15 to 0.17 µg/L PFOA = 0.058 to 0.13 µg/L PFBS = not detectable PFHxA = 0.0036 to 0.012 µg/L H4PFOS = 0.026 to 0.039 µg/L	<u>Operational Conditions:</u> Contact time: 1h Sedimentation over night Decantation

Case Study #2 - Fire-Fighting Water Treatment: Reference [VENDOR 51]

In a continuously operating filter column test (lab-scale) utilizing RemBind Plus as adsorbent and treating water samples containing 1.85 mg/L total PFAS (e.g. PFOS, PFBS PFOA, PFBA), the results revealed a removal efficiency of 100% within 40 BV and no breakthrough of the mentioned PFAS occurred. However, it is not clarified which concentration defined the breakthrough and final concentration levels of PFAS in the treated water as these were not given.

<u>Influent Water Composition:</u> PFOS = 0.027 µg/L PFOA = 0.43 µg/L PFBS = 0.17 µg/L PFBA = 0.21 µg/L		Sulphate = 44 mg/L	<u>System Design:</u> IEX: Purolite A532E Filter Volume, $V_F = 0.35$ L <i>Lab-scale</i>
<u>Breakthrough:</u> PFOS: 150,000 BV PFOA: 80,000 BV PFBS: 30,000 BV PFBA: 10,000 BV		<u>Operational Conditions:</u> $v_F = 3$ m/h EBCT = 10 min Flux = 6 BV/h	

Regeneration efficiency:

Unfortunately, an effective elution of PFAS from ion exchangers during regeneration cannot be reached with standard regeneration chemicals like acids or alkaline or saline solutions [123, 125, 126]. A more effective regeneration can be achieved by using both, a regenerant and an organic solvent like methanol or ethanol [1, 55, 123]. Anion exchangers with a smaller affinity to PFAS can be regenerated more effectively [124]. Often, weak basic anion exchangers (WBA) show a worse adsorption performance to PFAS than strong basic anion exchangers (SBA) and therefore can be regenerated more easily [1]. Furthermore, short-chain PFAS can be eluted easier than long-chain PFAS [1].

SBA Purolite A600E and Purolite A520E resins could be regenerated to a large extent by using ammonium chloride (NH_4Cl) and ammonia solution (NH_4OH) in concentrations of 0.5%. A successful regeneration with these exchangers could also be achieved using aqueous solutions of potassium chloride (KCl) and potassium hydroxide (KOH) in concentrations of 0.5% [124].

Case Study #2 - Ion exchange regeneration: Reference [55]

Complete regeneration of long-chain PFAS in pilot-scale could be achieved using a brine solution and an organic solvent. During the second adsorption cycle, no significant loss of performance was noticed and the same operation time as with fresh material was achieved.

<u>Influent Water Composition:</u> PFOS = 26 µg/L PFOA = 12 µg/L PFHxS = 22 µg/L 6:2 FTSA = 18 µg/L	<u>Operational Conditions:</u> $V_{\text{Regenerant}} = 10$ BV	<u>System Design:</u> IEX: SBA Sorbix A3F Filter Volume, $V_F = 35$ L
---	---	---

7.5. CUSTOMEM

In laboratory tests the CustoMem adsorbent exhibited ten times faster adsorption kinetics for PFOA than commercially available activated carbon and ion exchange resins as well as a two times larger adsorption capacity for PFOA [VENDOR 64].

Using a complex water matrix (water composition data not given), CustoMem provided an adsorption capacity as twice as high for PFOS, for the short-chain alkyl sulfonate PFBS and for the short-chain alkyl carboxylate PFBA [VENDOR 64].

Since it is unclear whether the activated carbon and the ion exchange resin that were utilized as a benchmark can be classified as very effective in PFAS removal (compared to other activated carbon types or ion exchange resins), the comparison data should be handled carefully.

Further, during the lab-scale experiments, a full regeneration success for PFOA after five times of usage was observed. For regeneration acidic and alkaline aqueous solutions are usually applied [VENDOR 64].

There is no published data about PFAS treatment with CustoMem currently available and hence, no case studies are presented.

7.6. CYCLODEXTRIN-BASED ADSORBENTS

In the studies below, the cyclodextrin-based adsorbent materials differ slightly from each other, due to the usage of different cross-linkers during the manufacturing process. In consequence, the affinity of the adsorbent towards PFAS changes and hence removal efficiency is affected.

Case Study #1 - Groundwater Treatment: Reference [70]

In lab-scale experiments using β -cyclodextrin coated silica as adsorbent for the treatment of spiked demineralized water samples, the removal efficiency for PFOA was about 95%.

<u>Influent Water Composition:</u> PFOA = 50 $\mu\text{g/L}$	pH 6.1 to 6.8	<u>System Design:</u> β -cyclodextrin coated silica Shaking exp. 1.5 g/L <i>Lab-scale</i>
<u>Effluent concentration:</u> PFOA = 2.5 $\mu\text{g/L}$		<u>Operational Conditions:</u> Contact time: 48 h

Case Study #2 - Groundwater Treatment and Fire-Fighting Water: Reference [66]

In batch experiments, treating a water with PFOA concentrations characteristic for groundwater PFOA was removed by 97%.

During treatment of a mixture of 10 different PFAS (concentration levels characteristic for fire-fighting wastewater) about 90% of the sum of PFAS was eliminated.

<u>Influent Water Composition:</u> PFOA = 25 $\mu\text{g/L}$	pH 5.5	<u>System Design:</u> β -cyclodextrin coated magnetite Shaking exp. 0.2 - 1.5 g/L <i>Lab-scale</i>
Sum of PFAS = 200 $\mu\text{g/L}$	pH 3.0	
<u>Effluent concentration:</u> PFOA = 0.75 $\mu\text{g/L}$		<u>Operational Conditions:</u> Contact time: 24 h
Sum of PFAS = 20 $\mu\text{g/L}$		

Case Study #3 - Groundwater Treatment: Reference [127]

Using cyclodextrin-coated magnetite as adsorbent, a removal efficiency of 99% for PFOS and of about 96% for PFOA was achieved (at pH 5.5). Adsorption experiments further indicate rapid adsorption kinetics.

When increasing the pH value from 5.5 to 7.0, the PFOA removal rate decreased from 96% to 85% and for a pH of 9.0 to almost 75%. At a solution pH above 10, removal efficiency declined to 50%. In comparison, the elimination of PFOS was less sensitive against pH changes, exhibiting still 97% at pH 9.0 and 86% at pH > 10.

<u>Influent Water Composition:</u> PFOS = 50 µg/L PFOA = 50 µg/L <p style="text-align: right;">pH 5.5</p>	<u>System Design:</u> β-cyclodextrin coated magnetite Shaking exp. 0.6 g/L <i>Lab-scale</i>
<u>Effluent concentration:</u> PFOS = 0.5 µg/L PFOA = 2.0 µg/L	<u>Operational Conditions:</u> Contact time: 24 h

Case Study #4 - Groundwater Treatment: Reference [66]

In lab-scale column experiments treating demineralized water an operation time of 6300 BV could be achieved until a breakthrough of PFOA and PFOS occurred (breakthrough was defined by an effluent concentration of 2.5 µg/L, each).

Regarding the impact of DOC towards the PFAS removal, it was observed that an increased DOC of 4 mg/L reduced the removal efficiency for PFOS from 97% to 82% and for PFOA from 90% to 60%. A further increased DOC of 12 mg/L diminished the PFOA removal down to 49%.

<u>Influent Water Composition:</u> Column exp. PFOS = 20 to 30 µg/L PFOA = 20 to 30 µg/L Shaking exp. PFOS = 50 µg/L PFOA = 50 µg/L	Column exp. deionized water DOC = 0 mg/L Shaking exp. deionized water DOC = 4 mg/L	<u>System Design:</u> β-cyclodextrin coated magnetite Shaking exp. 0.8 g/L <i>Lab-scale</i>
<u>Breakthrough:</u> Column exp. PFOS: 6300 BV PFOA: 6300 BV <u>Effluent concentration:</u> Shaking exp. PFOS = 1.5 µg/L PFOA = 5.0 µg/L	<u>Operational Conditions:</u> Column exp. Flux: 0.3 BV/h EBCT: 3 min Shaking exp. Contact time: 24 h	

Case Study #5 - Groundwater Treatment: Reference [67]

Comparing different porous cyclodextrin polymers, one has been identified to reduce PFOA with a removal efficiency of 99.9% to a concentration below 0.01 ng/L.

Further, contrary to the results from case study #4, evidence was found that a DOC of 20 mg/L had no significant impact on the PFOA removal efficiency.

<u>Influent Water Composition:</u> PFOA = 1 µg/L	deionized water	<u>System Design:</u> Porous cyclodextrin polymer Shaking exp. 0.01 g/L <i>Lab-scale</i>
<u>Effluent concentration:</u> PFOA < 0.01 µg/L		<u>Operational Conditions:</u> Contact time: 24 h

Case Study #6 - Groundwater Treatment: Reference [VENDOR]

Other experiments on the removal of short-chain and long-chain PFAS with initial concentrations of 1 µg/L, dosing of 10 g/m³ of Dexsorb+ resulted in removal efficiencies of about 92% and >99% for the single substances. In detail, removal efficiency for PFBA was >99%, and PFHxA and PFNA were eliminated by 95%. For PFHPA, PFOA, PFBS and PFHxS a removal rate of about 97% was achieved and PFOS was removed to about 92%.

<u>Influent Water Composition:</u> PFBA = 1 µg/L PFHxA = 1 µg/L PFHPa = 1 µg/L PFOA = 1 µg/L PFNA = 1 µg/L	PFBS = 1 µg/L PFHxS = 1 µg/L PFOS = 1 µg/L	<u>System Design:</u> Dexsorb+ Shaking exp. 0.01 g/L <i>Lab-scale</i>
<u>Effluent concentration:</u> PFBA = 0.01 µg/L PFHxA = 0.05 µg/L PFHPa = 0.03 µg/L PFOA = 0.03 µg/L PFNA = 0.05 µg/L		<u>Operational Conditions:</u> Contact time: 30 min

Case Study #7 - Fire-Fighting Water Treatment: Reference [VENDOR]

The table below show the results from a study conducted by Cyclopure treating a diluted AFFF solution with Dexsorb+ adsorbent. Unfortunately, no data on treatment system design and on operational conditions was available.

<u>Influent Water Composition:</u> PFOA = 6.60 µg/L PFHPa = 1.61 µg/L PFOS = 519 µg/L PFHxS = 76.3 µg/L PFBS = 11.4 µg/L	<u>System Design:</u> Dexsorb+ <i>Lab-scale</i>
<u>Effluent concentration:</u> PFOA = <i>not detectable</i> PFHPa = <i>not detectable</i> PFOS = 0.022 µg/L PFHxS = 0.001 µg/L PFBS = <i>not detectable</i>	<u>Operational Conditions:</u> -

Case Study #8 - Regeneration: References [67, 127]

The regeneration of the porous cyclodextrin polymer was investigated in batch experiments monitoring adsorption and desorption of PFOA for validation of the regeneration success. The results revealed a very efficient regeneration and no significant loss in adsorption capacity within four adsorption-regeneration-cycles.

<u>Influent Water Composition:</u> PFOA = 200 µg/L	<u>Operational Conditions:</u> Contact time: 12 h (= adsorption) Regeneration agent: methanol Regeneration time: 24 h (= desorption)	<u>System Design:</u> Porous cyclodextrin polymer Shaking exp. 0.4 g/L <i>lab-scale</i>
---	---	---

During regeneration experiments, using caustic soda combined with a NaCl solution a full regeneration of the adsorbent material within 10 adsorption-regeneration cycles without significant loss of removal efficiency has been reached. However, adsorbent dosage was much higher than in the experiments described above.

<u>Influent Water Composition:</u> PFOA = 200 µg/L PFOS = 200 µg/L	<u>Operational Conditions:</u> Contact time: 24 h (= adsorption) Regeneration agent: 0.2 M NaOH + 0.5 M NaCl Regeneration time: 24 h (= desorption)	<u>System Design:</u> Porous cyclodextrin polymer Shaking exp. 3.0 g/L <i>lab-scale</i>
--	---	---

7.7. PERFLUORAD

The removal efficiency for PFAS depends on the amount of PerfluorAd that is applied. Especially removal of short-chain PFCA is more efficient with increasing PerfluorAd dosage. A high dosage of 2 g/L leads to a removal of short-chain PFBA of about 77%, whilst only a removal efficiency of 6 to 30% was obtained when lower PerfluorAd amounts were dosed [4].

Case Study #1 - Groundwater Treatment: Reference [VENDOR 75]

When treating a groundwater contamination that occurred after a firefighting event, exhibiting initial PFAS concentrations of 589 µg/L, the removal efficiency was about 93.5% during pilot plant testing resulting in a final concentration of 38 µg/L. The amount of added flocculent is not specified.

Economic advantages will mainly occur if high concentrations of PFAS or if mainly short-chain PFCA are present. In literature, a value of overall PFAS concentrations above 0.3 µg/L is stated as high [4].

Two full scale case studies exist in Germany, both for groundwater remediation.

7.8. INSITE

The Australian company InSite Remediation Services offers an ex-situ treatment for PFAS removal from water (InTreat Water) based on a multistage flocculation/sedimentation approach (patent pending) that runs widely automatized [VENDOR 76].

The treatment system is arranged in a container and is capable to treat water volumes up to 140 m³/h (available pilot unit: 3.6 to 7.2 m³/h). The treatment plant consists of two continuous stirring tanks (reactors), one settling tank, an equalization tank and a subsequent polishing filter [VENDOR 76].

In the first step of the treatment process, contaminated influent water is mixed in a reactor with an additive (W) and the proprietary chemical InTreat. The mixture is stirred and after a certain residence time, the water is directed into a second reactor in which the chemical InTreat is added again. Subsequently, the water runs into a settling tank, where another additive (C) is added to enhance sedimentation. The sludge that settles in the reactors and the settling tank either can be recirculated or is collected for dewatering and further processing. The treated water from the settling tank flows into an equalization tank and is finally polished, e.g. with an adsorption filtration system. The backwash water from the filter is recirculated [VENDOR 76].

Case Study #1 - Fire-Fighting Water Treatment: Reference [VENDOR, 77]

Bench-scale experiments performed by the vendor revealed a total removal efficiency of 99.999%, for PFOS and PFHxS and 99.98% for PFOA simulating a two-stage treatment (two reactors) process. Final concentration levels were 0.02 µg/L for PFOS and PFHxS and below 0.1 µg/L PFOA without polishing.

<u>Influent Water Composition:</u> PFOS+PFHxS = 525 µg/L PFOA = 3.97 µg/L PFOS+PFHxS = 180 µg/L PFOA = 1.22 µg/L	deionized water well-water (flushing water from well development)	<u>System Design:</u> InTreat Water 1 g/L Lab-scale
<u>Effluent concentration:</u> PFOS < 0.02 µg/L PFHxS < 0.02 µg/L PFOA < 0.01 µg/L	for both, deionized water and well-water (flushing water from well development)	<u>Operational Conditions:</u> Contact time: 60 s (per reactor)

Case Study #2 - Fire-Fighting Water Treatment: Reference [VENDOR 76]

Experiments with a pilot unit treating a water with initial concentration of PFOS from 40 to about 380 µg/L, being comparable to concentration levels that are present in extinguishing waters, resulted in a removal efficiency of 99.99%. For influent concentrations below 120 µg/L, the InTreat process achieved an effluent concentration of 0.01 µg/L.

An achievement of the US-EPA threshold value of 0.07 µg/L could be realized for PFOS concentrations below 230 µg/L. In contrast, for influent concentrations above 300 µg/L the value of 0.07 µg/L PFOS was exceeded in the treated water. However, removal efficiency for PFOS was still 99.9% and the residual PFOS concentrations were below 0.11 µg/L.

<u>Influent Water Composition:</u> PFOS = 40 - 380 µg/L	<u>System Design:</u> InTreat Water Lab-scale
<u>Effluent concentration:</u> PFOS < 0.02 - 0.11 µg/L	<u>Operational Conditions:</u> Contact time: 60 s (per reactor)

7.9. NANOFILTRATION / REVERSE OSMOSIS

Removal efficiency for all PFAS by nanofiltration and especially reverse osmosis are between > 90% and > 99% relating to membrane type and PFAS [2, 78, 79, 80, 81]. RO membranes retain > 99% of PFAS. Also short-chain PFCA like PFBA and TFA (trifluoroacetic acid, containing a C2-chain) are nearly completely retained by RO membranes [82]. It can also be expected that most or nearly all precursors will be removed by filtration by RO membranes [4].

This high rejection efficiency of RO membranes also holds true at initial concentrations of PFOS up to 1,500 mg/L [5].

Several case studies exist within drinking water softening. In the south-western part of Germany at least four drinking water suppliers operate NF or RO membrane devices that removes PFAS due to a groundwater contamination in this area.

7.10. FOAM FRACTIONATION AND OZOFRACTIONATION

Foam fractionation is a technology that selectively separates PFAS from water by injection of compressed air (foam fractionation, SAFF by OPEC systems) or ozone (ozofractionation, OCRA by EVOGRA) in form of air bubbles into the water. Compared to technologies such as GAC-filtration the ozofractionation process requires more personnel to supervise and control the separation process [4].

The technology is capable to remove a bulk of PFAS and hence is applicable for pre-treatment purposes. Combined with a final polishing step (e.g. adsorption filtration), very low PFAS concentration levels in the ng/L range might be achievable. In case of ozofractionation the results presented below indicate that depending on the influent concentrations of the PFAS a final polishing step might not be absolutely essential [4, VENDOR 84, VENDOR, 128].

The SAFF system is available with treatment capacities ranging from 0.5 m³/h up to 10 m³/h [85]. According to the vendor, the system is capable to treat waters with PFAS concentrations ranging from 0.05 µg/L up to 50,000 µg/L [6, VENDOR 84].

Case Study #1 - Fire-Fighting Water Treatment: Reference [VENDOR 84]

Foam fractionation in a two-stage fractionation setup (SAFF) of groundwater containing PFOS, PFOA and PFHxS reduced about 99% of all three substances within a contact time of 15 minutes, without polishing.

Results indicate removal of further precursor compounds.

The final polishing removed the residual PFAS to concentrations below 0.07 µg/L for PFOS and PFHxS and to 0.56 µg/L for PFOA (representing the Australian health based guidance values for drinking water).

<u>Influent Water Composition:</u> PFOS = 21 µg/L PFHxS = 18 µg/L PFOA = 2.9 µg/L	groundwater	<u>System Design:</u> Two-stage fractionation with air <i>Pilot-scale</i>
<u>Effluent concentration:</u> PFOS = 0.01 µg/L PFHxS = 0.01 µg/L PFOA = 0.01 µg/L		<u>Operational Conditions:</u> Contact time: 15 min (per reactor)

Case Study #2 - Surface Water Treatment: Reference [4].

At an airport in Australia, the OCRA process was implemented to treat PFAS impacted surface water. The initial concentration levels of the PFAS are comparable to the levels in a contaminated groundwater and a multistage ozofractionation including a subsequent polishing step using a NF membrane was applied.

The removal efficiencies during the ozone fractionation (without polishing) was about 98% for PFOS and PFHxS, 97% for PFOA and 82% for PFPeA. The precursor substance H4PFOS was reduced by 99%. Further, the results indicate that polyfluorinated precursor substances such as H4PFOS or other polyfluorinated precursors were transformed into perfluorinated substances by ozone.

In total, with subsequent NF polishing an elimination rate of 99.99% (determined by TOP assay) was achieved.

<u>Influent Water Composition:</u> PFOS = 0.5 µg/L PFHxS = 0.5 µg/L PFOA = 0.3 µg/L PFHxA = 1.1 µg/L PFPeA = 1.0 µg/L H4PFOS = 18.4 µg/L	Surface water	<u>System Design:</u> Three-stage fractionation with ozone Polishing: nanofiltration <i>Large-scale</i>
<u>Effluent concentration:</u> PFOS = 0.01 µg/L PFHxS = 0.01 µg/L PFOA = 0.009 µg/L PFHxA = 0.01 µg/L PFPeA = 0.18 µg/L H4PFOS = 0.18 µg/L	without polishing	<u>Operational Conditions:</u> -

Case Study #3 - Groundwater Treatment: Reference [VENDOR, 128].

In this study, the OCRA process was used to treat groundwater at a PFAS contaminated site. The ozofractionation process revealed very good removal results for different long-chain and short-chain PFAS as well as for precursor substances, even for concentration levels below 0.2 µg/L. The concentrations of the PFAS that are of special interest in this report are given in the table below.

During a three-stage fractionation with ozone, PFOS and PFOA were removed by 99.9% and PFHxS even by 99.99%. Short-chain PFAS such as PFPeS were eliminated by 95%, PFHxA was reduced by 75%, PFPeA could be reduced by only 35% and PFBS by 63%. PFBA was removed by 99%. The precursor substance H4PFOS could be removed by 99.9%.

Other PFAS and precursor substances were present in concentrations ranging from 0.05 µg/L to 0.3 µg/L and could be already removed efficiently during the first ozofractionation stage by 97 to 99.9%.

After the GAC polishing, removal rate for the sum of all PFAS considered in the study was higher than 99.9%.

Influent Water Composition: PFOS = 52.2 µg/L PFHxS = 12.5 µg/L PFPeS = 1.27 µg/L PFBS = 1.9 µg/L PFOA = 1.2 µg/L PFHxA = 5.2 µg/L PFPeA = 2.0 µg/L PFBA = 1.0 µg/L H4PFOS = 1.89 µg/L		System Design: Three-stage fractionation with ozone Polishing: nanofiltration <i>Large-scale</i>
Effluent concentration: PFOS < 0.012 µg/L PFHxS = 0.001 µg/L PFPeS = 0.062 µg/L PFBS = 0.7 µg/L PFOA = 0.0005 µg/L PFHxA = 1.3 µg/L PFPeA = 2.0 µg/L PFBA = 0.002 µg/L H4PFOS = 0.001 µg/L		Operational Conditions: - without polishing

Case Study #4 - Fire-Fighting Water Treatment: Reference [4].

A large-scale implementation of ozofractionation at an airport in Australia using a NF unit for polishing to treat PFAS affected surface water and wastewater achieved a removal efficiency of 97% for the sum of 28 PFAS with inlet concentrations of 100 µg/L to 5,400 µg/L.

A specific example was the treatment of a water with a total PFAS concentration of 5,400 µg/L (mainly H4PFOS). Hereby, the plant showed a total removal efficiency of 99.999% with an outlet concentration of 0.04 µg/L total PFAS. During the treatment, 40,000 m³ water were reduced to a concentrate with the volume of 800 m³, representing a recovery of the process of 98%.

7.11. ELECTROCHEMICAL DEGRADATION

Experimental investigations yielded high degrees of PFAS degradation (batch reactor volume 1 L). Long-chain PFAS have been degraded better than short-chain PFAS and PFCA better than PFSA. During the degradation process, single chain links of the PFAS like CF₃ or C₂F₅ are released. This leads to an increased concentration of short-chain PFAS until a fully mineralisation occurs [2, 88, 89].

Case Study #1 - Groundwater Treatment: Reference [2, 88]

Treating a groundwater containing total PFAS concentrations of 260 µg/L for 120 h by electrochemical measures, a PFAS removal of 96% has been obtained. After treatment, only PFBS could be identified in a concentration of 10 µg/L. A fluoride mass balance demonstrated that the electrochemical treatment mineralised all detected PFAS and precursor substances completely.

DOC was also degraded to a degree of 96%. Because of long electrolysis time, a complete oxidation of bromide and chloride occurred and in consequence high concentrations of bromate (124 µg/L) and perchlorate (65 mg/L) were detectable in the treated water. The AOX in the treated water was about 2.7 mg/L.

In these experiments, energy consumption was about 1 W/L for a time of one hour (= 1 kWh/m³). Assuming a treatment time of 50 h, a total energy of 50 kWh/m³ is needed. However, it must be taken into account that this calculation is based on lab-scale experiments without considering any scale-up experimental results.

<u>Influent Water Composition:</u>	<u>Operational Conditions:</u>	<u>System Design:</u>
PFOS = 70 µg/L PFHxS = 120 µg/L PFBS = 16 µg/L DOC = 13 mg/L pH = 6.1	Current density: 2.3 mA/cm ² Power input: 1.4 W Electrolysis time: 120 h	Water Volume treated: 1 L <i>Lab-scale</i>

Case Study #2 - Membrane Eluat Treatment: Reference [2, 88]

The lab-scale treatment of a membrane filtration eluat with very high PFAS concentrations (4 to 16 mg/L) showed degradation efficiencies for PFOS, PFHxS and PFBS of about 80 to 90%, reaching final concentrations of about 700 µg/L for each of the three PFSA. DOC elimination was about 48%.

<u>Influent Water Composition:</u>	<u>Operational Conditions:</u>	<u>System Design:</u>
PFOS = 19,000 µg/L PFHxS = 10,000 µg/L PFBS = 4,000 µg/L DOC = 38 mg/L pH = 8.4	Power input: 0.9 W Electrolysis time: 18 h	Water Volume treated: 1 L <i>Lab-scale</i>

Case Study #3 - Industrial Wastewater Treatment: Reference [89]

During lab-scale investigations on the treatment of an industrial wastewater containing 1.6 mg/L PFAS, a degradation rate of 99.7% has been achieved. Through the demonstration of the degradation of the polyfluorinated compounds H4PFOS and 6:2 fluorotelomer sulfonamide alkylbetaine (6:2 FTAB), it may be expected that at least parts of existing precursors are degraded by electrochemical degradation.

The energy consumption is estimated to be about 256 kWh/m³.

<u>Influent Water Composition:</u>	<u>Operational Conditions:</u>	<u>System Design:</u>
PFOA = 2 µg/L PFHpA = 38 µg/L PFHxA = 25 µg/L PFPeA = 53 µg/L PFBA = 8 µg/L H4PFOS = 382 µg/L 6:2 FTAB = 1,143 µg/L TOC = 99 mg/L pH = 7.6 Conductivity = 6.9 mS/cm Chloride = 1,330 mg/L	Power input: 0.9 W Current density: 50 mA/cm ² Electrolysis time: 10 h	Water Volume treated: 2 L <i>Lab-scale</i>

7.12. OXIDATION PROCESSES

Because the chemical bond between carbon and fluorine is very stable, oxidation processes are not very efficient for the degradation of PFAS. Oxidation processes that are based on the production of hydroxyl radicals are not effective for PFOS and PFOA under normal waterworks operating conditions [3, 93, 129]. The results from laboratory scale investigations have been confirmed by single measurements at drinking water treatment plants [130, 131].

In contrast, sulphate radicals based AOP show a stronger degradation of different PFAS. Within a relative short reaction time, perfluorinated carboxylic acids like

PFOA can be transformed to hydrogen fluoride (HF) and carbon dioxide (CO₂), which means that a total mineralisation takes place. Perfluorinated sulfonic acids like PFOS, on the other hand, are not or only marginally degraded by sulphate radicals [80, 92, 93].

Case Study #1 - In-Situ Groundwater Treatment: Reference [94, 95]

An *in-situ* field demonstration using a persulfate-based oxidant mixture called OxyZone has been applied near an airport in the USA to treat a wide range of organic contaminants including PFAS [94, 95]. Various PFAS in the groundwater with a total concentration of about 300 µg/L were oxidised by this treatment with elimination rates between 21 and 79%. Mainly PFOS, PFHxS, and PFHxA have been detected in the groundwater and in the treated water. A complete PFAS mineralization by a fluorine mass balance has not been demonstrated.

7.13. SONO-CHEMISTRY

Microbubble collapse occurs with locally limited temperatures near 5,000 K. Thus, also the very stable chemical bonds between fluoride and carbon are destroyed [98].

Sono-chemical degradation rates increase with carbon-fluorine chain length [132].

Case Study #1 - Groundwater Treatment: Reference [98]

Following pseudo first-order kinetics, PFOS in a groundwater has been degraded by 68% during sono-chemical treatment. For PFOA a faster degradation has been observed: After 2 h, more than 90% of the initial concentration has been degraded.

<u>Influent Water Composition:</u> PFOS = 100 µg/L PFOA = 100 µg/L TOC = 20 mg/L pH = 6.9 - 7.9	<u>Operational Conditions:</u> Power density: 250 W/L Ultrasonic frequency: 350 kHz Reaction time: 2 h	<u>System Design:</u> Water Volume treated: 0.6 L <i>Lab-scale</i>
---	---	--

Case Study #2 - Fire-fighting Water Treatment: Reference [132]

Sono-chemical treatment of AFFF in different dilutions with ultrapure deionized water in pilot-scale demonstrated a degradation of long and short-chain PFAS. By the formation of larger amounts of fluorine and an increase in concentrations of detectable PFAS, a degradation of precursors has been demonstrated. A successive elimination of 6:2 fluorotelomer sulfonic acid and 8:2 fluorotelomer sulfonic acid could be reached. After a treatment time of 13 h, a degradation rate of about 90% was obtained for long-chain PFSA. In comparison, concentrations of long-chain PFCA have only decreased by 27%.

<u>Influent Water Composition:</u> pH = 4	<u>Operational Conditions:</u> Power density: 130 W/L Ultrasonic frequency: 350 kHz Reaction time: 13 h	<u>System Design:</u> Water Volume treated: 91 L <i>Pilot-scale</i>
--	--	---

Energy costs for sonolysis range between 100 and 300 kWh/m³ treated water [4]. Assuming an electric energy price of 0.15 €/kWh, specific treatment costs of 15 to 45 €/m³ result. Other cost estimations based on pilot-plan experiments [132] lead to costs of only one-tenth of the above-mentioned range. However, the experiments have been carried out at pH 4 and a degradation efficiency of 99% has been extrapolated. Furthermore, argon gas has been bubbled through the reactor before the experiment to increase the temperatures inside the cavitating bubbles and to increase the PFAS degradation efficiency.

Compared to results from experiments conducted at acidic conditions at a pH of 4, the degradation by sono-chemistry decreased to about 30% in the same experiments at a neutral pH of 6.5 [132].

7.14. UV RADIATION

There are no case studies about groundwater remediation or fire-extinguishing water treatment with UV-radiation reported.

However, experimental investigations using a UV lamp emitting light with wavelengths between 220 and 460 nm with a power of 200 W showed a degradation of PFOA with an initial concentration of 560 mg/L of 90%. This degradation rate however has been obtained after a long reaction time of three days [129]. At this stage of the experiment, PFOA has been transferred into fluoride, carbon dioxide and short-chain PFCA [133]. Thus, for a complete degradation, longer operation times are necessary and even higher energy costs occur.

Because short-chain PFAS are formed as intermediate products before a complete degradation occurs, short-chain PFAS are degraded more efficient than long-chain PFAS [133].

This high demand of energy can be explained with the absorption of vacuum UV radiation by the water. Vacuum UV radiation causes a production of OH radicals and the radiation cannot penetrate deep into the water [80]. Thus, for direct photolysis of PFAS by UV radiation, suitable reactors have to be used.

7.15. VACUUM DISTILLATION WITH PLASMA DESTRUCTION

According to the vendor, the VacuPlas treatment system has been applied for destruction of organic pollutants such as polychlorinated biphenyls, in which removal rates of 99.9999% are achieved. The removal efficiency for PFAS should be in the same order of magnitude. Further, the vendor described the distillation process of foaming liquids as the critical step during VacuPlas treatment [VENDOR].

The other studies described below are based on laboratory experiments investigating plasma treatment via formation of reactive species due to electrical discharge into the water. The reactive species decompose the PFAS (non-thermal plasma treatment).

Case Study #1 - Groundwater Treatment: Reference [104]

Treating PFAS contaminated groundwater via non-thermal plasma treatment, degradation rates of 60% for PFHxS, 85% for PFOA and almost 99% for PFOS were observed within a treatment time of 30 minutes. Degradation of the PFAS into short-chain PFAS was indicated.

The presence of co-contaminants, e.g. trichloroethene and tetrachloroethene did not cause minor degradation rates.

<u>Influent Water Composition:</u> PFOS = 1.2 µg/L PFOA = 0.21 µg/L PFHxS = 0.4 µg/L T = 15 °C Conductivity: 1150 µS/m TOC: 0.67 mg/L Co-contaminants: Trichloroethene = 3.6 µg/L Tetrachloroethene = 0.33 µg/L	<u>Operational Conditions:</u> Discharge frequency: 20 - 120 Hz Discharge voltage: - 16.5 - 25 kV Reaction time: 30 min Diffuser gas: Argon	<u>System Design:</u> Non-thermal plasma with gas bubbling Water volume treated: 3.8 L <i>Lab-scale</i>
--	---	--

Case Study #2 - Fire-Fighting Water Treatment: Reference [134]

Further experiments showed that the PFOA degradation via non-thermal plasma treatment was about 89%.

<u>Influent Water Composition:</u> Deionized water PFOA = 45 mg/L	<u>Operational Conditions:</u> Power consumption: 60 W Reaction time: 2.5 h Diffuser gas: Argon	<u>System Design:</u> Non-thermal plasma with gas bubbling Water volume treated: 0.2 L <i>Lab-scale</i>
---	--	--

Case Study #3 - Firefighting Water Treatment: Reference [135]

Hayashi et al. found that PFOA could be degraded by 98% during a reaction time of 3 h. For PFOS, a removal efficiency of 100% during a reaction time of 8 h was achieved. As described in other studies, both substances were degraded into shorter PFAS, resulting in the formation of TFA, PFBA, PFPeA, PFHxA, PFHpA, and PFOA. In general, the formation of other, potentially toxic by-products is only poorly investigated.

<u>Influent Water Composition:</u> PFOA = 42 mg/L PFOS = 120 mg/L	<u>Operational Conditions:</u> Power consumption: 95 W (in 3 h); 250 W (in 8 h) Reaction time: 3 - 8 h Diffuser gas: Argon	<u>System Design:</u> Non-thermal plasma with gas bubbling Water volume treated: 0.02 L <i>Lab-scale</i>
---	---	---

7.16. NANOSCALE ZEROVALENT IRON

Nanoscale zerovalent iron (nZVI) is a strong reductant and can be dosed as iron powder or is pre-dispersed and added as solution. Applied dosages range from 10 mg/L to 100 mg/L [108].

Only very few experimental data for ex-situ application is available. The case studies below describe laboratory experiments that are reported in peer-reviewed literature.

Case Study #1 - Groundwater Treatment: Reference [108]

Using magnesium-aminoclay coated zerovalent nanoscale iron, a removal rate higher than 70% for a mixture of PFAS was achieved. Thereby, the removal of the PFAS from water occurred due to degradation (about 40%) and adsorption (about 30%).

No formation of by-products was observed. Further, the same experiments were performed using uncoated nanoscale zerovalent iron. These tests resulted in no significant PFAS removal.

<u>Influent Water Composition:</u> Sum of PFAS = 200 µg/L	<u>Operational Conditions:</u> magnesium-aminoclay coated zerovalent nanoscale iron deionized water	<u>System Design:</u> Shaking exp. Iron dosage: 1 g/L Water volume treated: 0.1 L <i>Lab-scale</i>
--	--	--

Case Study #2 - Groundwater Treatment: Reference [110]

During other experiments, applying magnesium-aminoclay coated zerovalent iron, a removal efficiency of 38% for PFOA and 94% for PFOS could be achieved.

By increasing the dosage up to 1 kg/m³, no significant improvement of PFAS elimination could be observed. Using uncoated nanoscale iron on the other hand revealed significantly lower removal efficiencies.

Removal of the PFAS occurred to a majority due to adsorption onto the iron nanoparticles, whereas no reliable evidence was found that complete decomposition of the PFAS occurred. In consequence, residual amounts of PFAS must be considered.

<u>Influent Water Composition:</u> Sum of PFAS = 200 µg/L pH = 3	<u>Operational Conditions:</u> magnesium-aminoclay coated zerovalent nanoscale iron deionized water Reaction time: 1 h	<u>System Design:</u> Shaking exp. Iron dosage: 0.1 - 1 g/L Water volume treated: 0.1 L <i>Lab-scale</i>
--	--	--

7.17. WATER INCINERATION

There are no specific case studies about PFAS destruction with water incineration reported. Nevertheless, various special-waste incinerators like incineration plants of the chemical industry accept liquid waste for disposal using this technology.

8. ABBREVIATIONS

AC	Activated carbon
AFFF	Aqueous film forming foams
AOF	Adsorbable organically bound fluorine
AOP	Advanced oxidation process
BOD	Biochemical oxygen demand
BTX	Benzene, toluene, xylenes
BV	Bed volume
c	Concentration
COD	Chemical oxygen demand
DOC	Dissolved organic carbon
DFF	<u>D</u> ownhole <u>F</u> oam <u>F</u> ractionation
EBCT	Empty Bed Contact Time
EQS	Environmental Quality Standard
EU	European Union
FTAB	Fluorotelomer sulfonamid alkylbetaine
FTSA	Fluorotelomer sulfonic acid
GAC	Granular activated carbon
HCl	Hydrochloric acid
H ₂ PFDA	2H,2H-Perfluorodecanoic acid
H ₄ PFDS	1H,1H,2H,2H-Perfluorodecane sulfonic acid
HPFHpA	7H-Dodecafluoroheptanoic acid
H ₄ PFOS	1H,1H,2H,2H-Perfluorooctane sulfonic acid
H ₄ PFUnA	2H,2H,3H,3H-Perfluoroundecanoic acid
IEX	Ion exchanger
ITRC	Interstate Technology and Regulatory Council
ISS	In-situ soil mixing
NaCl	Sodium chloride
NaOH	Caustic soda
n.d.	Not detected
NF	Nanofiltration
OCRA	<u>O</u> zofractionative <u>C</u> atalyzed <u>R</u> eagent <u>A</u> ddition
q	Loading
PBT	Persistent, bioaccumulative and toxic

PFAS	Per- and polyfluoroalkyl substances
PFBA	Perfluorobutanoic acid
PFBS	Perfluorobutane sulfonic acid
PFCA	Per- and polyfluoroalkyl carboxylic acids
PFDA	Perfluorodecanoic acid
PFDoA	Perfluorododecanoic acid
PFHpA	Perfluoroheptanoic acid
PFHpS	Perfluoroheptane sulfonic acid
PFHxA	Perfluorohexanoic acid
PFHxS	Perfluorohexane sulfonic acid
PFNA	Perfluorononanoic acid
PFPeA	Perfluoropentanoic acid
PFPeS	Perfluoropentane sulfonic acid
PFOA	Perfluorooctanoic acid
PFOS	Perfluorooctane sulfonic acid
PFOSA	Perfluorooctane sulfonamide
PFSA	Per- and polyfluoroalkyl sulfonic acids
PFUnA	Perfluoroundecanoic acid
RO	Reverse osmosis
SAFF	Surface active foam fractionation
SBA	Strong basic anion exchangers
TFA	Trifluoro acetic acid
THP	Total petroleum hydrocarbons
TOP	Total oxidizable precursor
TZW	DVGW-Technologiezentrum Wasser
UBA	Umweltbundesamt (German Environmental Protection Agency)
US-EPA	US Environmental Protection Agency
UV	Ultra-violet (light)
V	volume
v_F	Filter velocity
VOC	Volatile organic compounds
WBA	Weak basic anion exchangers

9. REFERENCES

1. Janda J., Lange F.T., Riegel M. (2017) Weitergehende Erfassung von PFC-Quellen im Einzugsbereich von Wasserwerken und Entfernung von kurzkettigen, persistenten PFC, Final report of a project funded by German Association of Gas and Water (Deutscher Verein des Gas- und Wasserfachs (DVGW))
2. Schmidt K., Lipp P., Trautmann A., Thiem A. (2014) Entwicklung von Sanierungsverfahren für PFC-Schadensfälle am Beispiel des Flughafens Nürnberg, DVGW-Technologiezentrum Wasser, Karlsruhe, Final project report, Dec. 2014
3. Rahman M. F., Peldszus S., Anderson W. B. (2014) Behaviour and fate of perfluoroalkyl and polyfluoroalkyl substances (PFASs) in drinking water treatment: a review, *Water Res.*, 50, 318-340
4. Ross I., McDonough J., Miles J., Storch P., Kochunarayanan P.T., et al. (2018) A review of emerging technologies for remediation of PFASs, *Remediation*, 28, 101-126
5. Kucharzyk K.H., Darlington R., Benotti M., Deeb R., Hawley E. (2017) Novel treatment technologies for PFAS compounds: A critical review, *J. Environ. Manage.*, 204 (2), 757-764
6. Horst J., McDonough J., Ross I., Dickson M., Miles J., Hurst J., Storch P. (2018), Water Treatment Technologies for PFAS: The Next Generation. *Ground Water Monit. R.*, 38, 13-23
7. ITRC (Interstate Technology and Regulatory Council (2018) PFAS Technical and Regulatory Guidance document - Second Draft for Team review, Draft 7-31-18
8. ITRC (Interstate Technology and Regulatory Council (2018) Remediation Technologies and Methods for Per- and Polyfluoroalkyl Substances (PFAS), March 2018
9. Buck R.C., Franklin J., Berger U., Conder J.M., Cousins, I.T., de Voogt P., Astrup Jensen A., Kannan K., Mabury S.A., van Leeuwen S.P.J. (2011) Perfluoroalkyl and polyfluoroalkyl substances in the environment: terminology, classification, and origins, *Integr. Environ. Assess. Manag.*, 7 (4), 513-541
10. Ahrens L. (2011) Polyfluoroalkyl compounds in the aquatic environment: a review of their occurrence and fate, *J. Environ. Monitoring*, 13 (1) 20-31
11. Stahl T. (2013) Poly- und perfluorierte Chemikalien - Eigenschaften, Verwendung, Verhalten in der Umwelt und Nachweis in verschiedenen Matrices, Limburg, Jun. 12
12. Organisation for Economic Co-operation and Development (OECD), Portal on Per and Poly Fluorinated Chemicals, web side information, lastly retrieved 02.10.2018, <http://www.oecd.org/chemicalsafety/portal-perfluorinated-chemicals/>
13. Groundwater and Environmental Services (GES), The PFAS Primer, web side information, lastly retrieved 02.10.2018, <https://www.gesonline.com/insights/2018-01-12/pfas-primer>
14. Organisation for Economic Co-operation and Development (OECD) (2018) Toward a new comprehensive global database of per- and polyfluoroalkyl substances (PFASs):

Summery report on updating the OECD 2007 list of per- and polyfluoroalkyl substances (PFASs), Series on Risk Management No. 39

15. European Commission (2006) Directive 2006/122/EC of the European Parliament and of the council of 12 December 2006 amending for the 30th time Council Directive 76/769/EEC on the approximation of the laws, regulations and administrative provisions of the Member States relating to restrictions on the marketing and use of certain dangerous substances and preparations (perfluorooctane sulfonates), in. Official journal of the European Union 2006, 372/32
16. Stockholm Convention (2009) United Nations Environment Programme, The new POPs under the Stockholm Convention, <http://chm.pops.int/TheConvention/ThePOPs/TheNewPOPs/tabid/2511/Default.aspx>
17. Commission Regulation (EU) 2017/1000 of 13 June 2017 amending Annex XVII to Regulation (EC) No 1907/2006 of the European Parliament and of the Council concerning the Registration, Evaluation, Authorisation and Restriction of Chemicals (REACH) as regards perfluorooctanoic acid (PFOA), its salts and PFOA-related substances
18. U.S. EPA 2010/2015 PFOA Stewardship Programme 2009 <http://www.epa.gov/oppt/pfoa/pubs/stewardship/>
19. Renner R. (2006) The long and the short of perfluorinated replacements. *Environ. Sci. Technol.*, 40 (1), S. A12-13. DOI: 10.1021/es062612a.
20. Ritter S.K. (2010) Fluorochemicals Go Short. Shorter perfluoroalkyl chain lengths improve environmental profile of versatile stain-, grease-, and water-repelling chemicals, *Chem. Eng. News*, 88 (5), 12-17
21. Ahrens L., Taniyasu S., Yeung L.W.Y., Yamashita N., Lam P.K.S., Ebinghaus R. (2010) Distribution of polyfluoroalkyl compounds in water, suspended particulate matter and sediment from Tokyo Bay, Japan, *Chemosphere*, 79 (3), S. 266-272. DOI: 10.1016/j.chemosphere.2010.01.045.
22. Trenkle A. (2015) Transfer von poly- und perfluorierten Chemikalien (PFC) aus kontaminierten Böden in Nutzpflanzen, *VDLUFASchriftenreihe*, 71, 727-744
23. Pancras T., Schauwen G., Held T., Baker K., Ross I., Slenders H. (2016) Environmental fate and effects of poly- and perfluoroalkyl substances (PFAS), Concawe report no. 8/16, Brussels
24. Interstate Technology Regulatory Council (ITRC) PFAS Fact Sheets, web side information, lastly retrieved 02.10.2018, <https://pfas-1.itrcweb.org/fact-sheets/>
25. Umweltbundesamt (UBA) (2017) Fortschreibung der vorläufigen Bewertung von per- und polyfluorierten Chemikalien (PFC) im Trinkwasser: Empfehlung des Umweltbundesamtes nach Anhörung der Trinkwasserkommission, *Bundesgesundheitsblatt, Gesundheitsforschung, Gesundheitsschutz*, 60 (3), 350-352
26. European Commission (2018) Proposal for a directive of the European parliament and of the council on the quality of water intended for human consumption, 1.2.2018

27. US-EPA (2016) Fact sheet PFOA & PFOS drinking water health advisories, EPA 800-F-16-003, https://www.epa.gov/sites/production/files/2016-06/documents/drinkingwaterhealthadvisories_pfoa_pfos_updated_5.31.16.pdf
28. European Commission (2013) Directive 2013/39/EC of the European Parliament and of the council of 12 August 2013 amending Directives 2000/60/EC and 2008/105/EC as regards priority substances in the field of water policy
29. Interstate Technology Regulatory Council (ITRC) (2018) Aqueous Film-Forming Foam (AFFF)
30. Baduel C., Paxman C.J., Mueller J.F., (2015) Perfluoroalkyl substances in a firefighting training ground (FTG), distribution and potential future release, *J. Hazard. Mater.*, 296, 46-53
31. Place B.J. and Field J.A. (2012) Identification of Novel Fluorochemicals in Aqueous Film-Forming Foams Used by the US Military, *Environ. Sci. Technol.*, 46, 7120-7127
32. NewFields (2018) Technical Memorandum - Analysis of Firefighting Foam Concentrates - Draft, 27. March
33. Harding-Marjanovic K.C., Houtz E. F., Yi S., Field J. A., Sedlak D. L., Alvarez-Cohen L. (2015) Aerobic Biotransformation of Fluorotelomer Thioether Amido Sulfonate (Lodyne) in AFFF-Amended Microcosms, *Environ. Sci. Technol.*, 49 (13), 7666-7674
34. Backe W. J., Day T. C., Field J. A. (2013) Zwitterionic, cationic, and anionic fluorinated chemicals in aqueous film forming foam formulations and groundwater from U.S. military bases by nonaqueous large-volume injection HPLC-MS/MS, *Environ. Sci. Technol.*, 47 (10), 5226-5234
35. Weiner B., Yeung L.W.Y., Marchington E.B., D'Agostino L.A., Mabury S.A. (2013) Organic fluorine content in aqueous film forming foams (AFFFs) and biodegradation of the foam component 6 : 2 fluorotelomermercaptoalkylamido sulfonate (6 : 2 FTSAS), *Environ. Chem.*, 10 (6), 486-493
36. D'Agostino L.A., Marbury S.A. (2014) Identification of Novel Fluorinated Surfactants in Aqueous Film Forming Foams and Commercial Surfactant Concentrates, *Environ. Sci. Tech.*, 48 (1), 121-129
37. Wagner A., Raue B., Brauch H.-J., Worch E., Lange F.T. (2013): Determination of adsorbable organic fluorine from aqueous environmental samples by adsorption to polystyrene-divinylbenzene based activated carbon and combustion ion chromatography, *J. Chromatogr.*, A 1295, 82-89
38. Houtz E.F., Sedlak D.L. (2012) Oxidative Conversion as a Means of Detecting Precursors to Perfluoroalkyl Acids in Urban Runoff, *Environ. Sci. Tech.*, 46 (17), 9342-9349
39. Scheffey J., Darwin R., Leonard J. (1995) Evaluating firefighting foams for aviation fireprotection, *Fire Technol.*, 31, 224-243.
40. Gierig M. (2014) PFC Umweltproblematik. PFC-Schadensfälle - Erkundung, Sanierung und Zukunftsperspektiven. Bayerisches Landesamt für Umwelt. Augsburg, 08.04.2014

41. Schroers S., Valentin I. (2014) „Perfluorierte Chemikalien (PFC)“ Schadensfälle in NRW und Fallbeispiele, Präsentation auf der Fachtagung „PFC-Schadensfälle - Erkundung, Sanierung und Zukunftsperspektiven“, 8.4.2014, Augsburg
42. Hesse S., Ball Th., Baldauf G. (2014) PFC im Grundwasser - Aktuelle Fallbeispiele und Lösungsmöglichkeiten, *TZW-Schriftenreihe*, 65, 13-33
43. European Commission (2010) Technical guidelines for the identification of mixing zones pursuant to Art. 4(4) of the Directive 2008/105/EC [https://circabc.europa.eu/sd/a/182b4c92-719f-4176-80d7-fa742e123bd5/TECHNICAL%20GUIDELINES%20FOR%20THE%20IDENTIFICATION%20OF%20MIXING%20ZONES_C\(2010\)9369_EN.doc](https://circabc.europa.eu/sd/a/182b4c92-719f-4176-80d7-fa742e123bd5/TECHNICAL%20GUIDELINES%20FOR%20THE%20IDENTIFICATION%20OF%20MIXING%20ZONES_C(2010)9369_EN.doc)
44. Edel H., Korte D., Kellner C., Schwerte C., Rehnig U. (2015) PFC-Grundwassersanierungen - Technologie und Kosten aus über fünf Jahren Praxiserfahrung, *Sonderdruck aus KW - Korrespondenz Wasserwirtschaft*, 8 (9), 550-554
45. Sontheimer H., Crittenden J.C., Summers R.S (1985) Activated Carbon for Water Treatment, DVGW-Forschungsstelle, Karlsruhe, Germany
46. US-EPA (2017) Treatment of Perfluorinated Alkyl Substances in Wash Water Using Granular Activated Carbon and Mixed-Media, EPA/600/R-17/175
47. Eschauzier C., Beerendonk E., Scholte-Veenendaal P., De Voogt P. (2012) Impact of Treatment Processes on the Removal of Perfluoroalkyl Acids from the Drinking Water Production Chain, *Environ. Sci. Technol.*, 46 (3), 1708-1715
48. CRC CARE Fact sheet 12 - Perfluorochemicals
49. Das P., Arias V.A., Kambala V., Mallavarapu M., Naidu R. (2013). Remediation of Perfluorooctane Sulfonate in Contaminated Soils by Modified Clay Adsorbent—a Risk-Based Approach. *Water Air Soil Poll.*, 224, 1714, 10.1007/s11270-013-1714-y
50. CRC CARE. Naidu R. 20.10.2015. AFFF contaminated soil and water: risks, remedial options
51. Ziltek (2017) RemBind - Product overview: Immobilising Soil contaminants.
52. Chiang D., Stewart R., Birk G., Huang Q., Field J. (2017) Ability of Aluminum-based adsorbent to remove PFAS from Groundwater. Battelle fourth international symposium on bioremediation and sustainable environmental technologies. 22.5 - 25.5.2017. Miami, Florida.
53. Marquez N., Stewart R., Lawrence C., Kirk. J. (2016) A novel adsorption product of PFAS in wastewater from airport fire-training grounds. Ziltek and BECA
54. Yu Q., Zhang R., Deng S., Huang J., Yu G. (2009) Sorption of perfluorooctane sulfonate and perfluorooctanoate on activated carbons and resin: Kinetic and isotherm study, (eng), *Water Res.*, 43 (4), 1150-1158
55. Woodard S., Berry J., Newman B. (2017) Ion exchange resin for PFAS removal and pilot test comparison to GAC, *Remediation*, 27, 19-27
56. McCleaf P., Englund S., Östlund A., Lindegren K., Wiberg K., Ahrens L. (2017) Removal efficiency of multiple poly- and perfluoroalkyl substances (PFASs) in

- drinking water using granular activated carbon (GAC) and anion exchange (AE) column tests, *Water Res.*, 120, 77-87
57. Dudley L.-A. (2012) Removal of Perfluorinated Compounds by Powdered Activated Carbon, Superfine Powder Activated Carbon, and Anion Exchange Resin, Environmental Engineering, NC State University, Raleigh, NC
 58. Senevirathna S.T., Tanaka S., Fujii S., Kunacheva C., Harada H., Shivakoti B.R., Okamoto R. (2010) A comparative study of adsorption of perfluorooctane sulfonate (PFOS) onto granular activated carbon, ion-exchange polymers and non-ion-exchange polymers, (eng), *Chemosphere*, 80 (6), 647-651
 59. Lampert D.J., Frisch M.A., Speitel G.E. (2009) Removal of Perfluorooctanoic Acid and Perfluorooctane Sulfonate from Wastewater by Ion Exchange, *Pract. Period. Hazard. Toxic Radioact. Waste Manage.*, 11 (1), 60-68
 60. Deng S., Yu Q., Huang J., Yu G. (2010) Removal of perfluorooctane sulfonate from wastewater by anion exchange resins: effects of resin properties and solution chemistry, (eng), *Water Res.*, 44 (18), 5188-5195
 61. Crimi M. (2017) Project overview: Combined In Situ/Ex Situ Treatment Train for Remediation of Per- and Polyfluoroalkyl Substance (PFAS) Contaminated Groundwater, U.S. Department of Defense funded project (ER18-1306)
 62. Düsseldorf Airport: Düsseldorf Airport hat drei Grundwassersanierungsanlagen in Betrieb, web side information, lastly retrieved 16.03.2018, <https://www.dus.com/de-de/konzern/unternehmen/verantwortung/umweltschutz/gew%C3%A4sserschutz/grundwassersanierung>,
 63. Patent GB2551044A - Production of functionalised composite cellulose nanomaterials. Customem
 64. Hagemann H. CustoMem sustainable purity, presentation.
 65. A clean solution. *Industrial Fire Journal*. issue no. 111, First quarter 2018: 28 - 29
 66. Bhattarai. B. (2015) Development of novel adsorbents for the removal of emerging contaminants from water and wastewater. Dissertation, Temple University Philadelphia.
 67. Xiao L., Ling Y., Alsbaiee A., Li C., Helbling D. E., Dichtel W. R. (2017) β -Cyclodextrin Polymer Network Sequesters Perfluorooctanoic Acid at Environmentally Relevant Concentrations. *Journal of the American Chemical Society* Volume 139 (23) 7689-7692.
 68. Dichtel et al. (2018) United States Patent No.: US10 086 360 B2
 69. Cyclopure Product Data Sheet - DEXSORB+
 70. Bhattarai B., Muruganandham M., Suri R. P.S. (2014) Development of high efficiency silica coated β -cyclodextrin polymeric adsorbent for the removal of emerging contaminants of concern from water. *Journal of Hazardous Materials*, Volume 273, 146-154.

71. Appleman T.D., Higgins C.P., Quiñones O., Vanderford B.J., Kolstad C., Zeigler-Holady J.C., Dickenson E.R. (2014) Treatment of poly- and perfluoroalkyl substances in U.S. full-scale water treatment systems, *Water Res.*, 15 (51), 246-255
72. Lundgren S. (2014) Evaluation of the efficiency of treatment techniques in removing perfluoroalkyl substances from water. Examination paper, University of Uppsala
73. Cornelsen M. (2015) Neues Verfahren zur Entfernung von per- und polyfluorierten Chemikalien aus komplex belasteten Wässern, *gwf-Wasser|Abwasser*, 9, 918-925
74. Sankey J. (2017) Treatment of Perfluoroalkyl and Polyfluoroalkyl Substances (PFASs) in Soil and Water, conference contribution, Bettering Environmental Stewardship & Technology, 10-12th May, Whistler, BC, USA
75. Cornelsen M. (2017) Treatment of PFAS Contaminated Firefighting Waters, conference contribution, Lastfire Firefighting foam summit, 17-18th October, Budapest / Hungary
76. InTreat Water: PFAS Water treatment, technology description flyer
77. CRC CARE 2017, 7th International Contaminated Site Remediation Conference incorporating the 1st International PFAS Conference: Program and Proceedings, CleanUp 2017 Conference, Melbourne, Australia, 10 - 14 September 2017. p. 71, Anderson P. Insite Remediation Services PFAS water treatment process innovation tested
78. Tang C.Y., Fu Q.S., Criddle C.S., Leckie J.O. (2007) Effect of Flux (Transmembrane Pressure) and Membrane Properties on Fouling and Rejection of Reverse Osmosis and Nanofiltration Membranes Treating Perfluorooctane Sulfonate Containing Wastewater, *Environ. Sci. Technol.*, 41 (6), 2008-2014
79. Lipp P., Sacher F., Baldauf G. (2012) Removal of organic micro-pollutants during drinking water treatment by nanofiltration and reverse osmosis, *Desalin. Water Treat.*, 13 (1-3), 226-237
80. Lutze H., Panglisch S., Bergmann A., Schmidt T.C. (2012) Treatment Options for the Removal and Degradation of Polyfluorinated Chemicals, in *The Handbook of Environmental Chemistry, Polyfluorinated Chemicals and Transformation Products*, T. P. Knepper and F. T. Lange, Eds., Berlin, Heidelberg: Springer, 2012, 103-125
81. Dickenson E.R.V., Higgins C. (2016) Treatment Mitigation Strategies for Poly- and Perfluoroalkyl Substances, Web Report No. 4322, Water Research Foundation
82. Scheurer M., Nödler K., Freeling F., Janda J., Happel O., Riegel M., Müller U., Storck F.R., Fleig M., Lange Th. F., Brunsch A., Brauch H.-J. (2017) Small, mobile, persistent: Trifluoroacetate in the water cycle - Overlooked sources, pathways, and consequences for drinking water supply, *Water Res.*, 126, 460-471
83. DVGW-Arbeitsblatt W 235-1 (2009) Zentrale Enthärtung von Wasser in der Trinkwasserversorgung - Teil 1: Grundsätze und Verfahren, DVGW, Bonn
84. OPEC systems: PFAS Solutions, Brochure, OPEC Enviro Division, Belrose, New South Wales, Australia,
https://opecsystems.com/files/OPEC_Systems_PFAS_Solutions.pdf

85. Technology breakthrough for treatment of PFAS in surface water. *Waste + Water Management Australia*, Vol. 44, No. 5, Feb 2018: 24-25
86. Kumpabooth K., Osuwan S., Scamehorn J.F., Harwell J.H. (1999) Surfactant recovery from water using foam fractionation: Effect of temperature and added salt. United States: N. p.
87. Ahrens L., Harner T., Shoeib M., Lane D.A., Murphy J.G. (2012) Improved characterization of gas-particle partitioning for per- and polyfluoroalkyl substances in the atmosphere using annular diffusion denuder samplers, *Environ. Sci. Technol.*, 46 (13), 7199-206
88. Trautmann A.M., Schell H., Schmidt K.R., Mangold K.-M., Tiehm A. (2015) Electrochemical degradation of perfluoroalkyl and polyfluoroalkyl substances (PFASs) in groundwater, *Water Sci. Technol.*, 71 (10), 1569-1575
89. Gomez-Ruiz B., Gómez-Lavín S., Diban N., Boiteux V., Colin A., et al. (2017) Efficient electrochemical degradation of poly- and perfluoroalkyl substances (PFASs) from the effluents of an industrial wastewater treatment plant, *Chem. Eng. J.*, 322, 196-204
90. Niu J., Li Y., Shang E., Xu Z., Liu J. (2016) Electrochemical oxidation of perfluorinated compounds in water, *Chemosphere*, 146, 526-538
91. Radjenovic J., Sedlak D.L. (2015) Challenges and Opportunities for Electrochemical Processes as Next-Generation Technologies for the Treatment of Contaminated Water, *Environ. Sci. Technol.*, 49, 11292-11302
92. Lutze H. (2013) Sulfate radical based oxidation in water treatment, doctoral thesis, Universität Duisburg-Essen
93. Vecitis C.D., Park H., Cheng J., Mader B.T., Hoffmann M.R. (2009) Treatment technologies for aqueous perfluorooctanesulfonate (PFOS) and perfluorooctanoate (PFOA), *Front. Environ. Sci. Eng. China*, 3 (2), 129-151
94. Marley M., Moyer E., Ball R. (2017) Per- and Polyfluoroalkyl Substances (PFAS) Remediation Workshop, XDD Environmental, 18.10.2017, <http://www.xdd-llc.com/wp-content/uploads/2017/10/PFAS-Work-Shop-2017-UMASS-10-18-17.pdf>
95. Marley M., Moyer E., Ball R. (2017) Remedial Options for PFAS, XDD Environmental, 04.04.2017, <http://www.xdd-llc.com/wp-content/uploads/2017/03/Final-PFAS-2017-4-4-17.pdf>
96. Vecitis C.D., Park H., Cheng J., Mader B.T., Hoffmann M. R. (2008) Enhancement of Perfluorooctanoate and Perfluorooctanesulfonate Activity at Acoustic Cavitation Bubble Interfaces, *J. Phys. Chem. C.*, 112 (43). 16850-16857
97. Vecitis C.D., Park H., Cheng J., Mader B.T., Hoffmann M. R. (2009) Treatment technologies for aqueous perfluorooctanesulfonate (PFOS) and perfluorooctanoate (PFOA), *Front. Environ. Sci. Eng. China*, 3 (2). 129-151
98. Cheng J., Vecitis C.D., Park H., Mader B.T., Hoffmann M. R. (2008) Sonochemical Degradation of Perfluorooctane Sulfonate (PFOS) and Perfluorooctanoate (PFOA) in Landfill Groundwater: Environmental Matrix Effects, *Environ. Sci. Technol.*, 42 (21), 8057-8063

99. Cheng J., Vecitis C.D., Park H., Mader B.T., Hoffmann M. R. (2010) Sonochemical Degradation of Perfluorooctane Sulfonate (PFOS) and Perfluorooctanoate (PFOA) in Groundwater: Kinetic Effects of Matrix Inorganics, *Environ. Sci. Technol.*, 44 (1), 445-450
100. DVGW-Arbeitsblatt W 294-1 (2006) UV-Geräte zur Desinfektion in der Wasserversorgung; Teil 1: Anforderungen an Beschaffenheit, Funktion und Betrieb, DVGW, Bonn
101. econ industries: VacuPlas - Liquid Waste Management, web site information, lastly retrieved 20.05.2018, <https://www.econindustries.com/mobile-solutions/vacuplas-liquid-waste-management>
102. Gomez E., Amutha Rani D., Cheeseman C.R., Deegan D., Wise M., Boccaccini A.R. (2009) Thermal plasma technology for the treatment of wastes: A critical review. *J. Hazard. Mater.*, 161 (2-3), 614-626
103. Joshi R.P., Thagard S.M. (2013). Streamer-Like Electrical Discharges in Water: Part II. Environmental Applications. *Plasma Chem. Plasma. P.*, 33, 17-49.
104. Stratton G.R., Dai F., Bellona C.L., Holsen T.M., Dickenson E.R.V., Thagard S.M. (2017) Plasma-Based Water Treatment: Efficient Transformation of Perfluoroalkyl Substances in Prepared Solutions and Contaminated Groundwater, *Environ. Sci. Technol.*, 51 (3), 1643-1648
105. Merino N., Qu Y., Deeb R. A., Hawley E. L., Hoffmann M. R., Mahendra S. (2016) Degradation and Removal Methods for Perfluoroalkyl and Polyfluoroalkyl Substances in Water, *Environ. Eng. Sci.*, 33 (9)
106. Heberlein J., Murphy A.B. (2008) Thermal plasma waste treatment. *J. Phys. Applied Phys.*, 41 053001
107. Crane R. A., Scott T. B. (2012) Nanoscale zero-valent iron: Future prospects for an emerging water treatment technology, *Journal of Hazardous Materials*, Vol. 211-212, 112-125.
108. Arvaniti O. S., Hwang, Y., Andersen, H. R., Nikolaos, T. S., & Athanasios, S. S. (2014). Removal of Perfluorinated Compounds from Water using Nanoscale Zero-Valent Iron. Abstract from Singapore international Water Week, Singapore.
109. Park S., Zenobio J. E., Lee L. S. (2018) Perfluorooctane sulfonate (PFOS) removal with Pd₀/nFe₀ nanoparticles: Adsorption or aqueous Fe-complexation, not transformation? *Journal of Hazardous Materials*, 342, 20-28.
110. Arvaniti O. S., Hwang Y., Andersen H. R., Stasinakis A. S., Thomaidis N. S., Aloupi M. (2015) Reductive degradation of perfluorinated compounds in water using Mg-aminoclay coated nanoscale zero valent iron. *Chemical Engineering Journal*, 262, 133-139
111. Xin Zhang, Yu-man Lin, Zu-liang Chen (2009) 2,4,6-Trinitrotoluene reduction kinetics in aqueous solution using nanoscale zero-valent iron. *Journal of Hazardous Materials*, 165 (1-3) 923-927.
112. Yamada, T., Taylor P.H. (2003). Laboratory scale thermal degradation of perfluorooctanyl sulfonate and related precursors. Final Report, 3 M Company

113. Yamada T., Taylor P.H., Buck R.C., Kaiser M.A., Giraud R.J. (2005). Thermal degradation of fluorotelomer treated articles and related materials. *Chemosphere* 61, 974-984
114. Engler-Bunte-Institute, Division of Fuel Chemistry and Technology, Email information from the head of institute from 24th Mai 2018
115. Kolb T. (2003) Technische Verfahren der thermischen Abfallbehandlung. Presentation
116. Haist-Gulde B., Sacher F. (2015) Anforderungen an den Einsatz von Aktivkohlen zur Spurenstoffentfernung, Begleitbuch zur 11. Aachener Tagung Wassertechnologie, 27. - 28. October, 337-344
117. Ochoa-Herrera V., Sierra-Alvarez R. (2008) Removal of perfluorinated surfactants by sorption onto granular activated carbon, zeolite and sludge, (eng), *Chemosphere*, 72 (10), 1588-1593
118. Hansen M. C., Børresen M. H., Schlabach M., Cornelissen G. (2010) Sorption of perfluorinated compounds from contaminated water to activated carbon, *J. Soils Sediments*, 10 (2) 179-185
119. Eschauzier C., de Voogt P., Brauch H.-J., Lange F. T. (2012) Polyfluorinated Chemicals in European Surface Waters, Ground- and Drinking Waters, in *The Handbook of Environmental Chemistry, Polyfluorinated Chemicals and Transformation Products*, T. P. Knepper and F. T. Lange, Eds., Berlin, Heidelberg: Springer, 73-102
120. TZW (2011) Wasserwerk Weilerbach - Adsorptive Entfernung von Spurenstoffen, Report
121. TZW (2015) Auswahl geeigneter Sorbentien zur Entfernung von PFC, Report
122. Kambala et al. (2016) United States Patent No.: US9,284,201 B2
123. Albers M. (2011) Analytik und Elimination von perfluorierten Tensiden aus Prozesswässern der Galvanik, doctoral thesis, Bergische Universität Wuppertal
124. Zaggia A., Conte L., Falletti L., Fant M., Chiorboli A. (2016) Use of strong anion exchange resins for the removal of perfluoroalkylated substances from contaminated drinking water in batch and continuous pilot plants, *Water Res.*, 91, 137-146
125. Schuricht F., et al. (2014) Entfernung des perfluorierten Tensids PFOS aus Abwasserströmen der galvanischen Industrie / Teil 1, *Galvanotechnik*, 9, 2062-2072
126. Carter K.E., Farrell J. (2010) Removal of Perfluorooctane and Perfluorobutane Sulfonate from Water via Carbon Adsorption and Ion Exchange, *Sep. Sci. Technol.*, 45 (6), 762-767
127. Badruddoza A. Z. M., Bhattarai B., and Suri R. P. S. (2017) Environmentally Friendly β -Cyclodextrin-Ionic Liquid Polyurethane-Modified Magnetic Sorbent for the Removal of PFOA, PFOS, and Cr(VI) from Water. *ACS Sustainable Chemistry & Engineering*, Volume 5 (10), 9223-9232.

128. EVO CRA, 10.03.2017. OCRA use in decontamination of PFOS, PFOA and short chain precursor (SCP) contaminated water. Technical paper.
129. Fujii S., Tanaka S., Hong Lien N.P., Qiu Y., Polprasert C. (2007) New POPs in the water environment: Distribution, bioaccumulation and treatment of perfluorinated compounds - a review paper, *J. Water Supply: Res. Technol.--AQUA*, 56 (5), 313
130. Shivakoti B.R., Fujii S., Nozoe M., Tanaka S., Kunacheva C. (2010) Perfluorinated chemicals (PFCs) in water purification plants (WPPs) with advanced treatment processes, *Water Sci. Technol.: Water Supply*, 10 (1), 87-95
131. Martijn B.J., Kruithof J. C. (2014) Robustness of a MP UV/H₂O₂ - GAC multibarrier against emerging contaminants, New Orleans, Nov. 16
132. Gole V.L., Sierra-Alvarez R., Peng H., Giesy J.P., Deymier P., Keswani M. (2018) Sono-chemical treatment of per- and poly-fluoroalkyl compounds in aqueous film-forming foams by use of a large-scale multi-transducer dual-frequency based acoustic reactor, *Ultrason. Sonochem.*, 45, 213-222
133. Hori H., Hayakaiva E., Einaga H., Kutsuna S., Koike K., Ibusuki T., Kiatagawa H., Arakawa R. (2004) Decomposition of environmentally persistent perfluorooctanoic acid in water by photochemical approaches. *Environ. Sci. Technol.*, 38 (22), 6118-6124
134. Obo H., Takeuchi N., Yasuoka K. (2013) Decomposition of Perfluorooctanoic Acid in Water Using Multiple Plasma Generation, *IEEE T. Plasma Sci.*, 41 (12), 3634-3639
135. Hayashi R., Obo H. Takeuchi N., Yasuoka K. (2015) Decomposition of Perfluorinated Compounds in Water by DC Plasma within Oxygen Bubbles, *Electr. Eng. Jpn.*, 190, 9-16
136. Alther, G.R. (2002) Removing oils FROM WATER with organoclays. *Journal - American Water Works Association*, 94: 115-121. doi:10.1002/j.1551-8833.2002.tb09512.x
137. Lath S., Navarro D. A., Losic D., Kumar A., McLaughlin M. J. (2018) Sorptive remediation of perfluorooctanoic acid (PFOA) using mixed mineral and graphene/carbon-based materials. *Environmental Chemistry* 15, 472-480.
138. Stewart, R. (2016) Immobilisation and safe disposal of aqueous film forming foam (AFFF) impacted soil in Australia, Platform presentation, Proceedings of Battelle International Bioremediation Symposium, Miami, USA.
139. Hinrichsen, H. (2019) Stabilisation of PFAS contaminated soil. Poster presentation, AquaConSoil Conference, Antwerp, Belgium, 20-24 May, 2019.
140. Orange County Water District, U.S (2019) Press release December 4, 2019, <https://www.ocwd.com/media/8349/ocwd-pfas-pilot-press-release.pdf> (retrieved 2020-02-27)
141. Ling, Y.; Alzate-Sanchez, D. M.; Klemes, M. J.; Dichtel, W. R.; Helbling, D. E. (2020) Evaluating the effects of water matrix constituents on micropollutant removal by activated carbon and b-cyclodextrin polymer adsorbents. *Water Research*, 173, 115551

142. Zhang, K.; Huang, J.; Yu, G.; Zhang, Q.; Deng, S.; Wang, B. (2013) Destruction of Perfluorooctance Sulfonate (PFOS) and Perfluorooctanoic Acid (PFOA) by Ball Milling. *Environ. Sci. Technol.*, 47, 6471
143. Crittenden, J.C.; Trussell, R.R.; Hand, D.W.; Howe, K.J., Tchobanoglous, G. (2005) *Water Treatment: Principles and Design*, Second Edition, MWH, John Wiley & Sons
144. Stauder, S.; Riedinger, P. (2017) Umkehrosmose und Kornaktivkohle zur Enthärtung und PFC-Elimination in Baden-Baden, 22. TZW-Kolloquium, 103-125, 05.12.2017
145. econ industries: Per- and Poly- Fluoroalkyl Substances (PFAS) Management - A Strategic Approach. Technology Summary, 18.04.2019

Concawe
Boulevard du Souverain 165
B-1160 Brussels
Belgium

Tel: +32-2-566 91 60
Fax: +32-2-566 91 81
e-mail: info@concawe.org
<http://www.concawe.eu>

ISBN 978-2-87567-126-4



9 782875 671264 >